

# WALL 3350 Full-Motion TV Wall Mount

Article number (SKU) 8354130  
 Colour Black

## Key benefits

- Smoothly turn your TV up to 120°
- Hide all unsightly cables
- Screen Protection System - Protect your TV from bumping into the wall
- Ultra strong - built for heavy TVs
- Also suitable for a tv in a cabinet or niche
- Use the app and mark the first drilling hole easily!

## Full motion TV wall mount with double support arms for TVs up to max. 45 kg

The WALL 3350 is designed especially for extra-large and heavy TVs. A solid mount for TVs from 40" to 65" (101-165 cm). The maximum turning angle is 120° and the max. tilting angle is 15°.

## Sturdy construction thanks to double support arms, also for large and heavy TVs

The unique construction with two support arms ensures a stable and powerful weight capacity. The Screen Protection System prevents your TV from touching the wall.

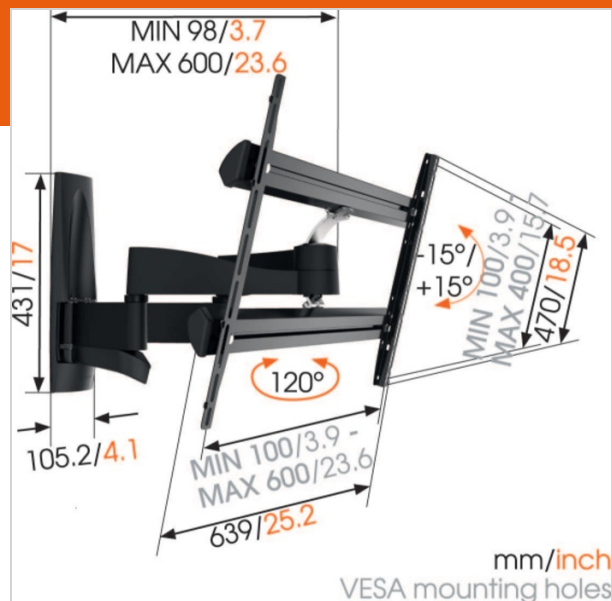



# WALL 3350 Full-Motion TV Wall Mount

VOGEL'S HOLDING BV 2017 (c) All rights reserved  
 Subject to printing errors, technical and price  
 amendments  
 Date: 13-12-2017

[www.vogels.com](http://www.vogels.com)

## Specifications

### Product specifications

Product type number	WALL 3350
Article number (SKU)	8354130
Colour	Black
EAN single box	8712285335587
Product size	L
TÜV certified	Yes
Tilt	Tilt up to 15°
Turn	Up to 120° - ultra strong
Guarantee	Lifetime
Min. screen size (inch)	40
Max. screen size (inch)	65
Max. weight load (kg)	45
Min. hole pattern	100mm x 100mm
Max. hole pattern	600mm x 400mm
Max. bolt size	M8
Max. height of interface (mm)	470
Max. width of interface (mm)	639

### Features

Special features	Cable guiding included
Functionality	Turn
Number of arms	4
Number of pivot points	4

### Technical specifications and dimensions

Min. distance to the wall (mm)	98
Max. distance to the wall (mm)	600

