

BOSE



T4S/T8S ToneMatch® Mixer

Owner's Guide
Guía del propietario
Notice d'utilisation
Bedienungsanleitung
Manuale di istruzioni
Gebruikershandleiding
取扱説明書
用户指南
使用者指南
دليل المالك

Important Safety Instructions

Please read and keep all safety and use instructions.

1. Read these instructions.
2. Keep these instructions.
3. Heed all warnings.
4. Follow all instructions.
5. Do not use this apparatus near water.
6. Clean only with a dry cloth.
7. Do not block any ventilation openings. Install in accordance with the manufacturer's instructions.
8. Protect the power cord from being walked on or pinched, particularly at plugs, convenience receptacles, and the point where they exit from the apparatus.
9. Only use attachments/accessories specified by the manufacturer.
10.  Use only with the cart, stand, tripod, bracket, or table specified by the manufacturer or sold with the apparatus. When a cart is used, use caution when moving the cart/apparatus combination to avoid injury from tip-over.
11. Unplug this apparatus during lightning storms or when unused for long periods of time.
12. Refer all servicing to qualified personnel. Servicing is required when the apparatus has been damaged in any way such as power-supply cord or plug is damaged, liquid has been spilled or objects have fallen into the apparatus, the apparatus has been exposed to rain or moisture, does not operate normally, or has been dropped.

WARNINGS/CAUTIONS:



This product contains magnetic material. Consult your physician on whether this might affect you implantable medical device.

- This product is not intended for installation or use in indoor water facility areas (including, without limitation, indoor pools, indoor water parks, hot tub rooms, saunas, steam rooms and indoor skating rinks).
- To reduce the risk of fire or electrical shock, do NOT expose this product to rain, liquids or moisture. Not applicable for products rated IPX4-9.
- Keep the product away from fire and heat sources. Do NOT place naked flame sources, such as lighted candles, on or near the product.
- Do NOT make unauthorized alterations to this product.
- Do NOT use a power inverter with this product.
- Do NOT use in vehicles or boats.
- Use this product only with the power supply provided.
- Do NOT place or install the bracket or product near any heat sources, such as fireplaces, radiators, heat registers or other apparatus (including amplifiers) that produce heat.
- Do not use the ToneMatch® T4S/T8S mixer with a tripod/stand that is unstable. The mixer is only designed for use on a 1/4" screw (6 mm), and the tripod/stand must be capable of supporting a device with a minimum weight of 1.9 kg (4.1 lbs) and an overall size of 214 x 311 x 83 mm (8.4 x 12.25 x 3.25 inches). Using a tripod/stand that is not designed to support the size and mass of the T4S/T8S mixer may lead to an unstable and hazardous condition that could result in injury.
-  Contains small parts which may be a choking hazard. Not suitable for children under age 3.

NOTES:

- The speaker wire and interconnect cables included with this system are not approved for in-wall installation. Please check your local building codes for the correct type of wire and cable required for in-wall installation.
- Where the mains plug or an appliance coupler is used as the disconnect device, the disconnect device shall remain readily operable.
- Due to ventilation requirements, Bose does not recommend placing the product in a confined space such as in a wall cavity or in an enclosed cabinet.

Regulatory Information

This device complies with part 15 of the FCC Rules and with Industry Canada license-exempt RSS standard(s). Operation is subject to the following two conditions: (1) This device may not cause harmful interference, and (2) this device must accept any interference received, including interference that may cause undesired operation.



This product conforms to all applicable EU directive requirements. The complete Declaration of Conformity can be found at www.Bose.com/compliance.

This product conforms to all applicable Electromagnetic Compatibility Regulations 2016 and all other applicable UK regulations. The complete declaration of conformity can be found at: www.Bose.com/compliance.

Information About Products That Generate Electrical Noise (FCC Compliance Notice for US)

Note: This equipment has been tested and found to comply with the limits for a Class A digital device, pursuant to part 15 of the FCC Rules. These limits are designed to provide reasonable protection against harmful interference when the equipment is operated in a commercial environment. This equipment generates, uses, and can radiate radio frequency energy and, if not installed and used in accordance with the instruction manual, may cause harmful interference to radio communications. Operation of this equipment in a residential area is likely to cause harmful interference in which case the user will be required to correct the interference at one's own expense.

Changes or modifications not expressly approved by Bose Corporation could void the user's authority to operate this equipment.

Shielded cables are required to maintain regulatory compliance.

This product complies with the Canadian ICES-003 Class A specifications.

CAN ICES-3(A)/NMB-3(A)

This product meets all EN55103-2 immunity requirements for E2 electromagnetic environment.

Names and Contents of Toxic or Hazardous Substances and Elements

Part Name	Toxic or Hazardous Substances and Elements					
	Lead (Pb)	Mercury (Hg)	Cadmium (Cd)	Hexavalent (CR(VI))	Polybrominated Biphenyl (PBB)	Polybrominated diphenylether (PBDE)
PCBs	X	0	0	0	0	0
Metal parts	X	0	0	0	0	0
Plastic parts	0	0	0	0	0	0
Speakers	X	0	0	0	0	0
Cables	X	0	0	0	0	0

This table is prepared in accordance with the provisions of SJ/T 11364.

0: Indicates that said hazardous substance contained in all of the homogenous materials for this part is below the limit requirement of GB/T 26572.

X: Indicates that said hazardous substance contained in at least one of the homogenous materials used for this part is above the limit requirement of GB/T 26572.



This symbol means the product must not be discarded as household waste, and should be delivered to an appropriate collection facility for recycling. Proper disposal and recycling helps protect natural resources, human health, and the environment. For more information on disposal and recycling of this product, contact your local municipality, disposal service, or the shop where you bought this product.

For China:



仅适用于海拔 2000m 以下地区安全使用

Only suitable for use at areas with altitude less than 2000 m.

Introduction

Product Overview 5
 Product Features 5
 Unpacking 5

Control and Connection Panels

T4S ToneMatch® Mixer 6
 Control Panel 6
 Connection Panel 7
 T8S ToneMatch® Mixer 8
 Control Panel 8
 Connection Panel 9

System Setup

Removing/Attaching the Cover 10
 Mounting Options 11
 Mounting the T4S/T8S on a Camera Tripod Stand 11
 Connecting the T4S via Digital Connection 12
 Connecting the T4S/T8S via Analog Connection 13
 Connecting the ToneMatch® Power Supply 14
 Connecting the T4S/T8S to Your Computer 15
 Connecting a Flash Drive to the T4S/T8S 15

Operation

Reading the T4S/T8S Display 16
 Optimizing Input Gain and Output Volume 17
 Using the Master Volume Control 18
 Muting a Channel 18
 Muting Channel Effects 18
 Using the Rotary Selector 19
 Editing the Sound of a Channel 20
 Using the Pan/Aux Functions 20
 Using the Tuner 20
 Selecting a ToneMatch® Preset 22
 Adjusting zEQ 22
 Adjusting Para EQ 23
 Using Compressor/Gate Functions 23
 Using Modulation Effects 25
 Adding Delays 26
 Adding Reverb 26

Contents

Using Global Functions	27
Selecting a Reverb Type	27
Using the Prefs Utilities	28
Loading and Saving Scenes	30
Sharing a Scene	33
Bose Scenes	35
Factory Settings	35
Singer/Songwriter	36
DJ/Playback	38
Full Band	40

Factory Settings

Factory Settings	42
------------------------	----

Care & Maintenance

Troubleshooting	43
Cleaning	46
Technical Information	46

Additional Resources

Contact Information	47
Importer Information	47
Additional Information	47
Limited Warranty	47

Product Overview

Take control of your music with T4S and T8S ToneMatch® mixers, compact 4 and 8 channel interfaces designed for performers. Engineered with powerful DSP engines and intuitive user controls, they offer studio-quality EQ, dynamics and effects processing. Sound great with integrated Bose® ToneMatch® processing and zEQ, especially when connected to a Bose L1 or F1 system for full end-to-end tonal control. Play confidently on stage with these rugged ToneMatch mixers using tactile controls, easy-to-read LED displays and scene recall. ToneMatch mixers, the ultimate on-stage companions for performing artists.

Product Features

Powerful Audio Processing

- Updated, studio-quality effects with advanced digital audio processing
- Effects include compressor, limiter, de-esser, noise gate, chorus, flanger, phaser, tremolo, delay, and reverb
- Bose® ToneMatch® processing for natural-sounding vocals and instruments
- zEQ focuses the sound of ToneMatch presets for effective adjustments on the fly
- Independent ToneMatch, EQ, dynamics and effects per channel
- Dedicated reverb for Aux sends, and a global shared reverb for use across all channels
- Master output EQ helps compensate for venue acoustics
- Full end-to-end tonal optimization when used with Bose L1 and F1 systems

Seamless Live Control

- Tactile controls and indicators designed for live on-stage use by musicians and DJs
- Fast-learning user interface
- Built-in tap tempo delay, chromatic tuner, and recallable scenes
- LED display and illuminated controls are easy to read and use, even on dimly-lit stages

High-Density Connectivity



- Unprecedented connectivity and control in a small digital stereo mixer
- Four (T4S) or eight (T8S) high-quality audio preamps with XLR-combo jacks for microphones or instruments, and switchable phantom power
- Two Aux inputs for additional sources two (T4S) or four (T8S) Aux sends
- USB-A and -B for USB drive playback or PC/Mac interfacing
- ToneMatch outputs for digital audio and power (T4S only)
- Balanced ¼" TRS and XLR (T8S only) stereo outputs
- Independent headphone output

Convenient Gig-Ready Features

- Rugged enclosure with a protective magnetic cover to protect controls and connectors
- Includes a ToneMatch cable for connecting to a Bose L1 Model II or L1 Model 1S system for digital audio and power (T4S), or includes a universal power supply (T8S)
- Bottom insert allows you to use standard camera mounting accessories to keep your ToneMatch mixer within reach

Unpacking

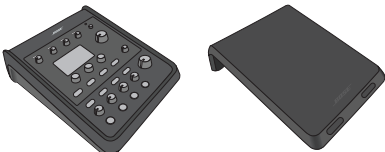
See the following table for what your mixer carton will include:

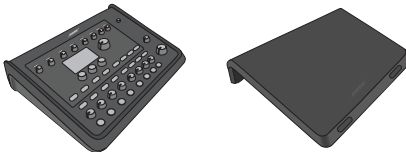
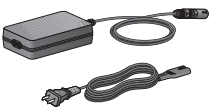
T4S	 <p>T4S ToneMatch mixer and cover</p>	 <p>ToneMatch Cable</p>
T8S	 <p>T8S ToneMatch mixer and cover</p>	 <p>ToneMatch power supply</p>

For a complete list of optional equipment and accessories, please visit www.Bose.com.

T4S ToneMatch® Mixer

Control Panel

Figure 1. T4S Control Panel

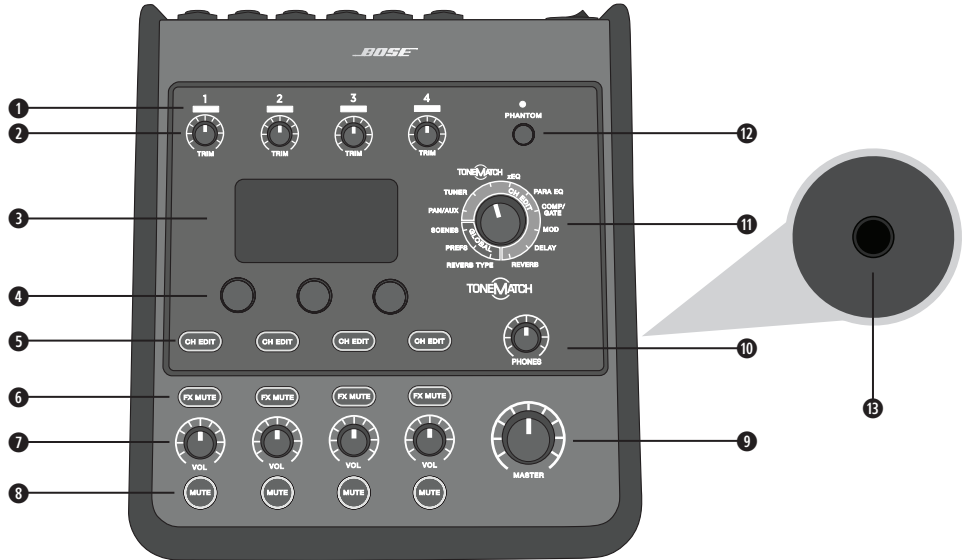

- 1 INPUT SIGNAL/CLIP LEDs (1-4)** – Displays the input signal status in color:
Green: Indicates the presence of an input signal
Red: Indicates input source clipping
- 2 TRIM CONTROLS (1-4)** – Adjusts the input sensitivity for the respective channel.
- 3 DISPLAY** – Provides function menus and system information.
- 4 EDITING CONTROLS** – These three rotary/push-button controls allow you to select or adjust items/values appearing on the display.
- 5 CH EDIT BUTTONS (1-4)** – Selects the channel you want to modify.
- 6 FX MUTE BUTTONS (1-4)** – Bypasses the Mod, Delay, and Reverb effects on the selected channel.
- 7 VOLUME CONTROLS (1-4)** – Adjusts the volume level for the respective channel.
- 8 MUTE BUTTONS (1-4)** – Silences the audio output for the respective channel.
- 9 MASTER VOLUME CONTROL** – Adjusts the overall output level.
- 10 HEADPHONE VOLUME CONTROL** – Adjusts the volume level of the headphone output.
- 11 ROTARY SELECTOR** – Allows access to both global and channel-related parameters, which are adjusted using the editing controls.
- 12 PHANTOM POWER SWITCH** – Applies +48V power to input channels 1-4. A red LED indicates that phantom power is on.
- B HEADPHONE JACK** – For use with headphones only, with a minimum impedance of 24Ω.

Connection Panel

Figure 2. T4S Connection Panel

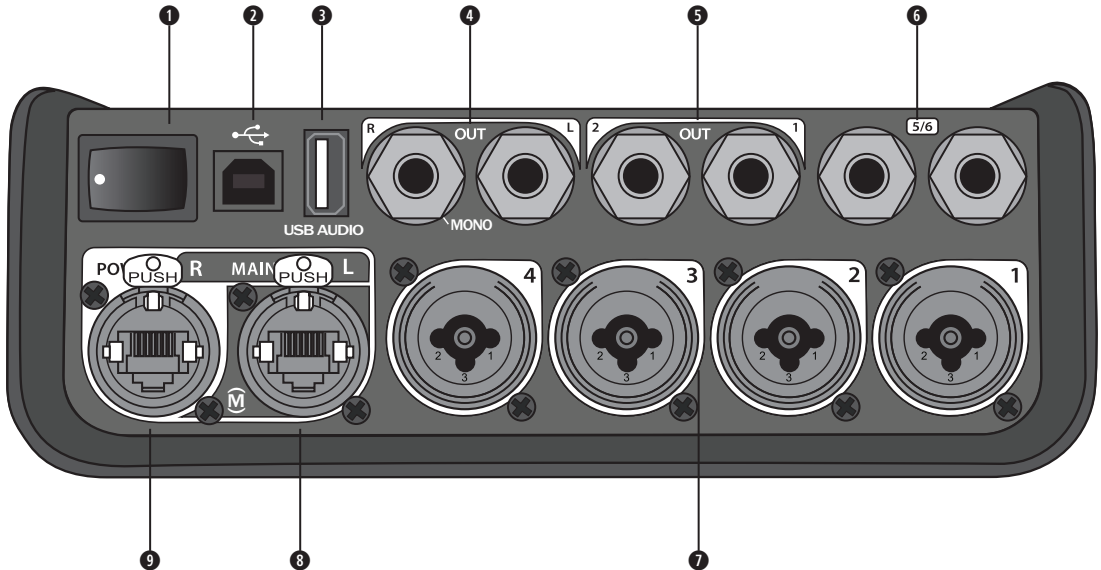

- ❶ **POWER SWITCH** – Turns the mixer on or off.
- ❷ **USB 2.0 TYPE-B** – A USB interface that allows you to connect the mixer to your computer.
- ❸ **USB 2.0 TYPE-A** – A USB interface that allows you to stream audio from your flash drive.
- ❹ **ANALOG L/R OUTPUT** – Main analog output. Accepts ¼" TRS balanced or TS unbalanced cables.
- ❺ **AUX OUTPUT** – Two user-definable analog outputs. Can be configured for a pre-fader, post-EQ, and effects, or post-fader output. Accepts ¼" TRS balanced cables.
- ❻ **AUX IN** – Analog input channels 5/6. Accepts ¼" TRS balanced or TS unbalanced cables for line-level inputs. Can be used for stereo input signals.
- ❼ **INPUTS 1-4** – Analog input channels 1-4. Accepts XLR balanced cables for microphones or ¼" TRS balanced or TS unbalanced cables for high-impedance inputs, such as guitars.
- ❸ **DIGITAL MAIN OUTPUT L** – Connect digitally in stereo to two L1® Model 1S/II systems. **Note:** Only used in stereo with Digital Main Output R.
- ❹ **POWER PORT/DIGITAL MAIN OUTPUT R** – A digital output used by the L1 Model 1S/II system. Delivers power to the T4S mixer from the L1 Model 1S/II power stand. Can also deliver power from an AC outlet via a ToneMatch power supply (not included with the T4S). Accepts the included ToneMatch® cable.



CAUTION: Although the ToneMatch port accepts a standard RJ-45 connector, do NOT connect the T4S to a computer or phone network.

T8S ToneMatch® Mixer

Control Panel

Figure 3. T8S Control Panel

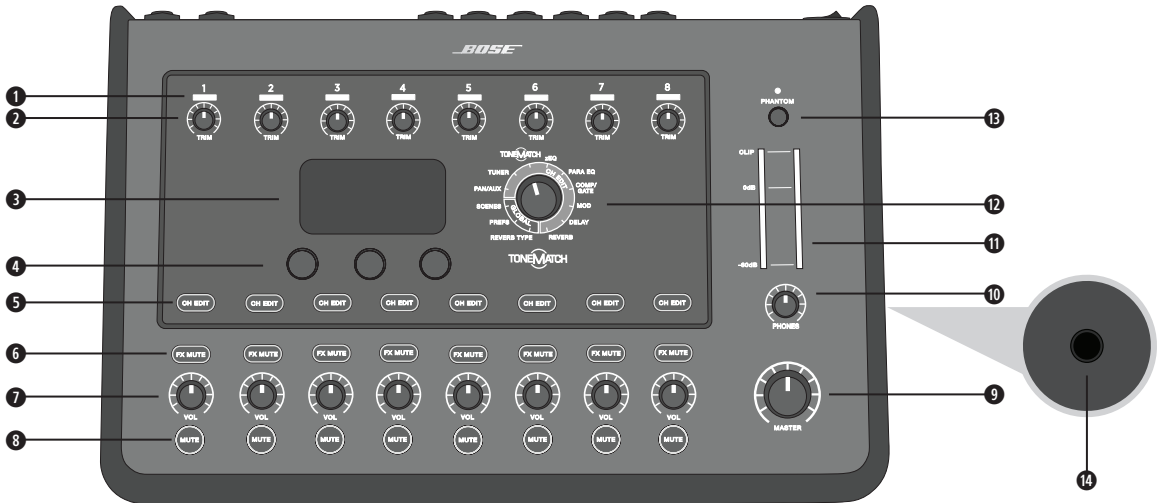

- 1 INPUT SIGNAL/CLIP LEDs (1-8)** – Displays the input signal status in color:
Green: Indicates the presence of an input signal
Red: Indicates input source clipping
- 2 TRIM CONTROLS (1-8)** – Adjusts the input sensitivity for the respective channel.
- 3 DISPLAY** – Provides function menus and system information.
- 4 EDITING CONTROLS** – These three rotary/push-button controls allow you to select or adjust items/values appearing on the display.
- 5 CH EDIT BUTTONS (1-8)** – Selects the channel you want to modify.
- 6 FX MUTE BUTTONS (1-8)** – Bypasses the Mod, Delay, and Reverb effects on the selected channel.
- 7 VOLUME CONTROLS (1-8)** – Adjusts the volume level for the respective channel.
- 8 MUTE BUTTONS (1-8)** – Silences the audio output for the respective channel.
- 9 MASTER VOLUME CONTROL** – Adjusts the overall output level.
- 10 HEADPHONE VOLUME CONTROL** – Adjust the volume level of the headphone output.
- 11 STEREO OUTPUT METER** – Allows you to visually measure your output level.
- 12 ROTARY SELECTOR** – Allows access to both global and channel-related parameters, which are adjusted using the editing controls.
- 13 PHANTOM POWER SWITCH** – Applies +48V power to input channels 1-8. A red LED indicates that phantom power is on.
- 14 HEADPHONE JACK** – For use with headphones only, with a minimum impedance of 24Ω.

Connection Panel

Figure 4. T8S Connection Panel

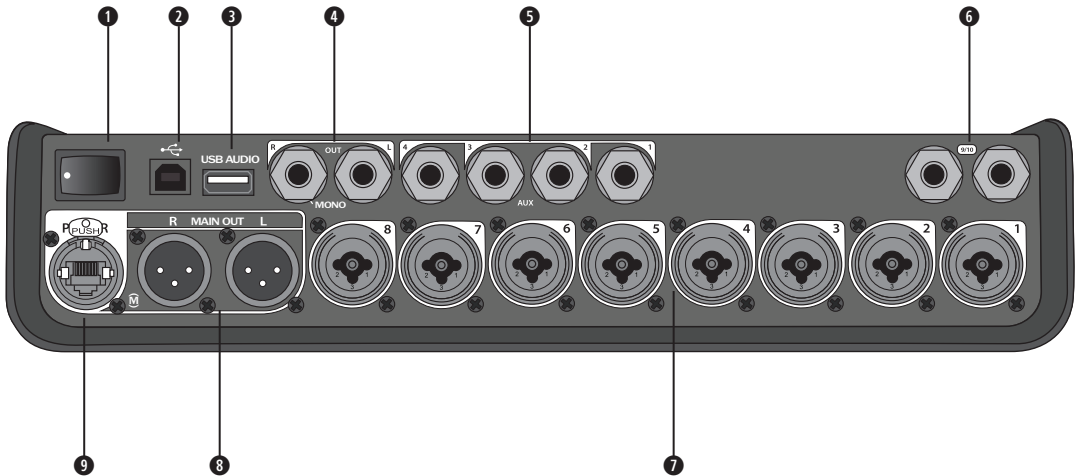

- ❶ **POWER SWITCH** - Turns the mixer on or off.
- ❷ **USB 2.0 TYPE-B** - A USB interface that allows you to connect the mixer to your computer.
- ❸ **USB 2.0 TYPE-A** - A USB interface that allows you to stream audio from your flash drive.
- ❹ **ANALOG L/R OUTPUT** - Main analog output. Accepts 1/4" TRS balanced and TS unbalanced cables.
- ❺ **AUX OUTPUT** - Four user-definable analog outputs. Can be configured for a pre-fader, post-EQ, and effects, or post-fader output. Accepts 1/4" TRS balanced or TS unbalanced cables.
- ❻ **AUX IN** - Analog input channels 9/10. Accepts 1/4" TRS balanced or TS unbalanced cables for line-level inputs. Can be used for stereo input signals.
- ❼ **INPUTS 1-8** - Analog input channels 1-8. Accepts XLR balanced cables for microphones or 1/4" TRS balanced or TS unbalanced cables for high-impedance inputs, such as guitars.
- ❽ **XLR STEREO OUTPUT** - Stereo analog output. Accepts XLR balanced cables for stereo output.
- ❾ **DIGITAL POWER PORT** - For use w/ ToneMatch power supply (see "Connecting the ToneMatch® Power Supply" on page 14).

Note: The T8S is NOT designed to connect digitally to the L1® Model 1S/II.



CAUTION: Although the ToneMatch port accepts a standard RJ-45 connector, do NOT connect the T8S to a computer or phone network.

Removing/Attaching the Cover

The T4S/T8S ToneMatch® mixer comes out of the carton with a cover installed on the top panel. The cover is designed to protect the control panel while transporting or storing the mixer.

To remove the cover:

1. Place thumbs on notches on front of cover and slide cover forward.
2. Grab cover by the back and lift to remove it.

To attach the cover:

1. Slide cover over the mixer, from back to front.
2. The magnetized cover will engage on its own and secure itself to the mixer.

Figure 5. Removing and attaching the cover

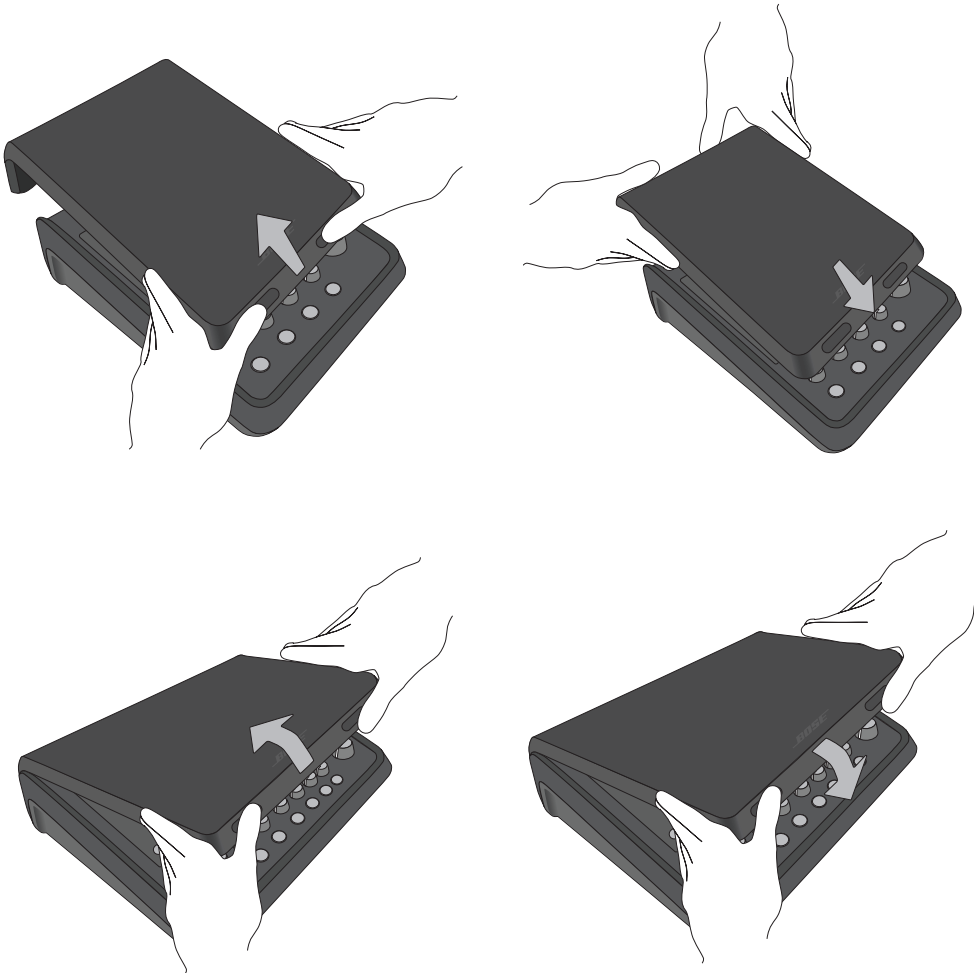

Mounting Options

The T4S/T8S comes with a ¼" (6 mm) mounting screw insert. This enables it to be mounted onto a number of available products that include a ¼" (6 mm) mounting screw, including a camera tripod stand.

Mounting the T4S/T8S on a Camera Tripod Stand

1. Extend the camera tripod legs and secure at desired height.
2. Remove the bracket from the top of the camera tripod stand and secure the bracket to the bottom of the T4S/T8S with the screw. Make sure the small indentation on the T4S/T8S and the bump on the bracket are aligned. See Figure 6.
3. Secure the bracket with the T4S/T8S back onto the camera tripod stand. See Figure 8.

Figure 6. Securing bracket to T4S

Figure 8. Mounting T4S to tripod stand using bracket

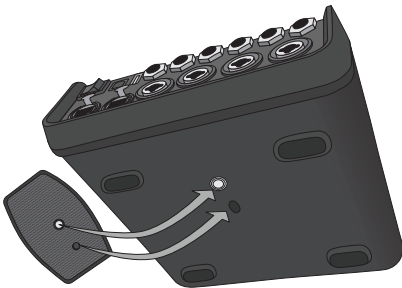
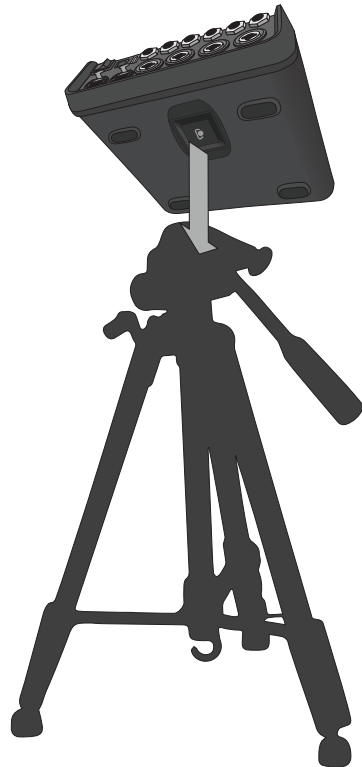

Figure 7. Bracket attached to T4S



WARNING: Do not use the ToneMatch® T4S/T8S mixer with a tripod/stand that is unstable. The mixer is only designed for use on a ¼" screw (6 mm), and the tripod/stand must be capable of supporting a device with a minimum weight of 1.9 kg (4.1 lbs) and an overall size of 214 x 311 x 83 mm (8.4 x 12.25 x 3.25 inches). Using a tripod/stand that is not designed to support the size and mass of the T4S/T8S mixer may lead to an unstable and hazardous condition that could result in injury.

System Setup

Connecting the T4S via Digital Connection

1. Make sure the L1 Model 1S/II and T4S are powered off and the T4S Master volume control is set to minimum.
2. Plug one end of the ToneMatch® cable into the Power port/Digital Main Output R on the T4S. Plug the other end of the ToneMatch cable into the ToneMatch port on the power stand.
Note: To connect the T4S to two L1 Model 1S/II power stands, connect a second power stand to the Digital Main Output L port on the T4S using a ToneMatch cable.
3. Turn on the mixer and then turn on the L1 Model 1S/II power stand.
4. Connect your instruments and adjust levels. Refer to “Optimizing Input Gain and Output Volume” on page 17.

Figure 9. Two L1 model II systems connected to a T4S via digital connection

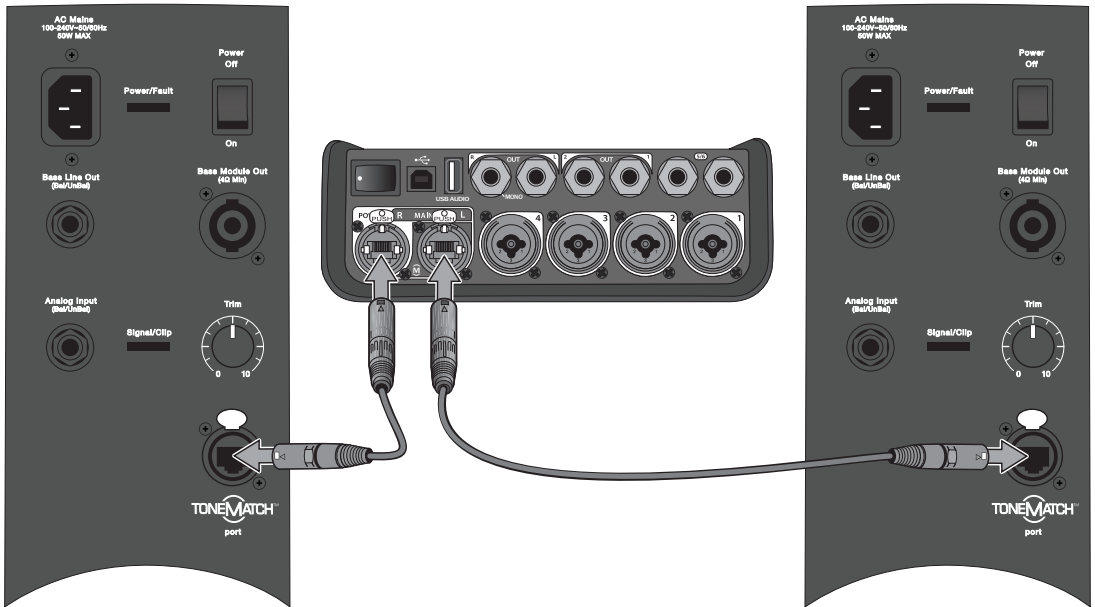

Note: The T8S cannot be connected digitally and cannot be powered by the L1 Model 1S/II.

Connecting the T4S/T8S via Analog Connection

1. Make sure the device you are connecting to and the T4S/T8S are powered off and the T4S/T8S Master volume control is set to minimum.
2. Using XLR balanced cables, connect one or two devices to the XLR Stereo Outputs of your T8S (see Figure 10).

Note: The T4S/T8S can be connected to a device via the Analog R Output port using a 1/4" TRS cable (sold separately). Plug the other end of the TRS cable into the Analog Input port of the device. To connect the T4S/T8S to two devices, connect a second device to the Analog L Output port on the T4S/T8S using a 1/4" TRS cable.

3. Connect a ToneMatch® power supply to the Power port of the T4S/T8S and plug it into a live AC outlet. Refer to “Connecting the ToneMatch® Power Supply” on page 14.
4. Turn on the T4S/T8S mixer and then turn on the device.
5. Connect your instruments and adjust levels. Refer to “Optimizing Input Gain and Output Volume” on page 17.

Figure 10. Two F1 systems connected to a T8S via analog connection

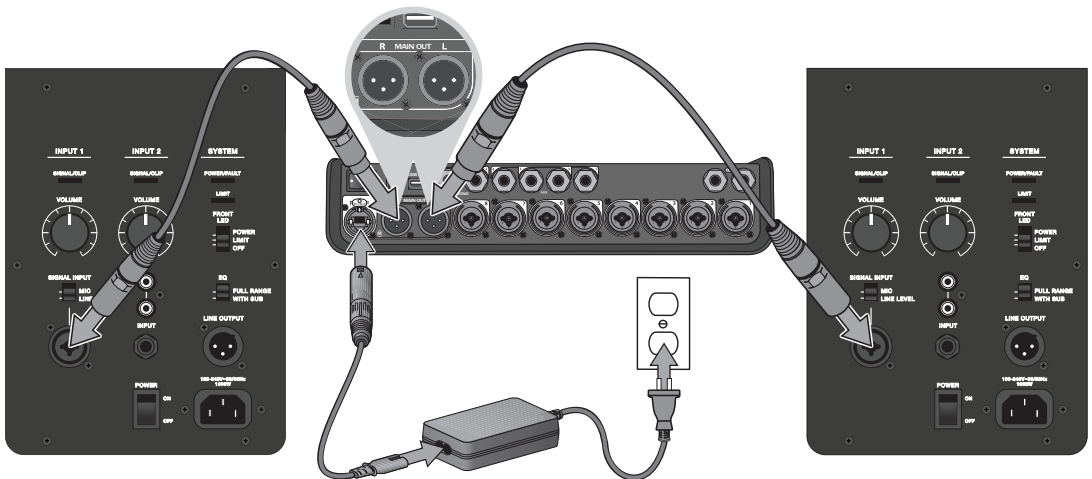

System Setup

Connecting the ToneMatch® Power Supply

The ToneMatch power supply provides power for the T4S/T8S mixer.

1. Plug the power supply cable into the T4S/T8S Power port.
2. Plug one end of the AC power cord into the power supply.
3. Plug the other end of the power cord into a live AC power outlet.
4. Switch the T4S/T8S power switch to the ON position.

Note: Power supply included with T8S is required for operation of the T8S. Power supply is not included with the T4S and is not required for operation of the T4S.

Figure 11. Connecting T4S to power supply

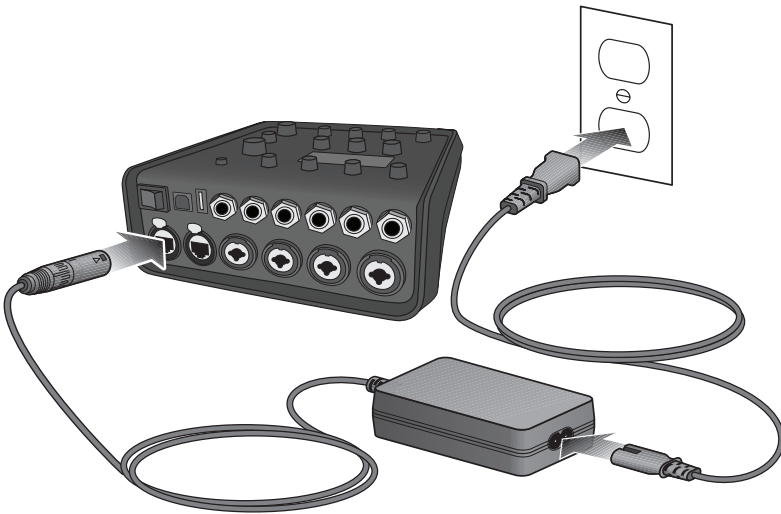

Connecting the T4S/T8S to Your Computer

The T4S/T8S provides a USB port for connecting it to a computer. This allows you to download performance scenes to a computer or install system updates. Visit bosepro.link/tmu for details on updating your system.

When connected to a computer, you also can use the T4S/T8S as a general-purpose USB audio device for recording/playback.

Note: The T4S/T8S operates at 48 kHz/24-bit. When using the T4S/T8S with recording software, you may need to configure the software settings for 48 kHz/24-bit operation.

Note: Connecting the T4S/T8S to your computer requires a USB cable (Type A to Type B, not supplied).

1. Connect the mixer to a power source (ToneMatch® power supply for T4S/T8S or an L1 Model 1S/II for T4S only).
2. Plug one end of the USB cable into the mixer's USB 2.0 Type-B port (Figure 12).
3. Plug the other end of the USB cable into a USB port on your computer.
4. Turn on the mixer.

Figure 12. T4S-to-USB connection

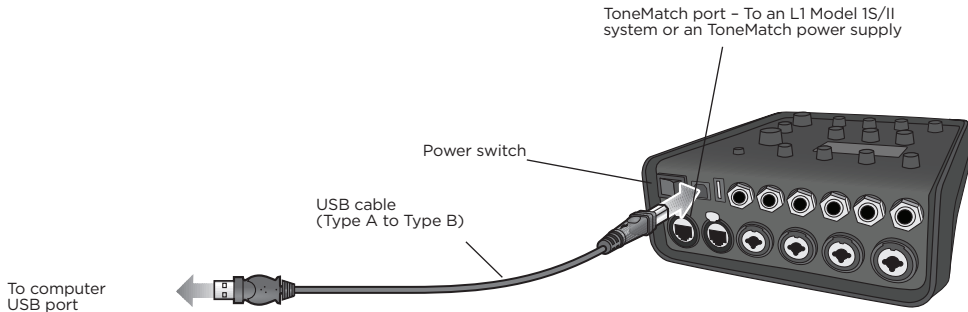

Connecting a Flash Drive to the T4S/T8S

Plug in a USB 2.0/3.0 flash drive loaded with WAV/MP3 files into the USB 2.0 Type-A port to playback audio tracks to your mixer.

Figure 13. Connecting a flash drive to the T4S

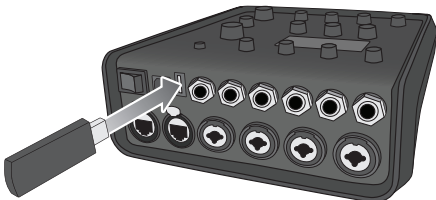

Reading the T4S/T8S Display

The display provides you with an interface for operating the mixer. Figure 14 shows a sample of display information and the basic operating conventions. The content of the display depends on the rotary selector position.

Figure 14. Sample display and operating conventions

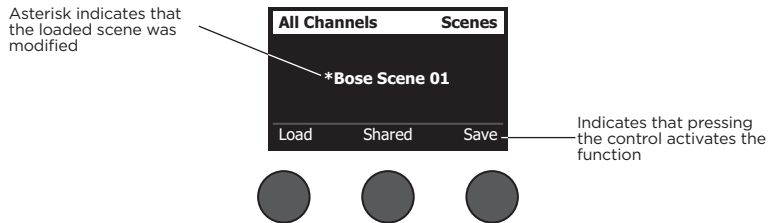
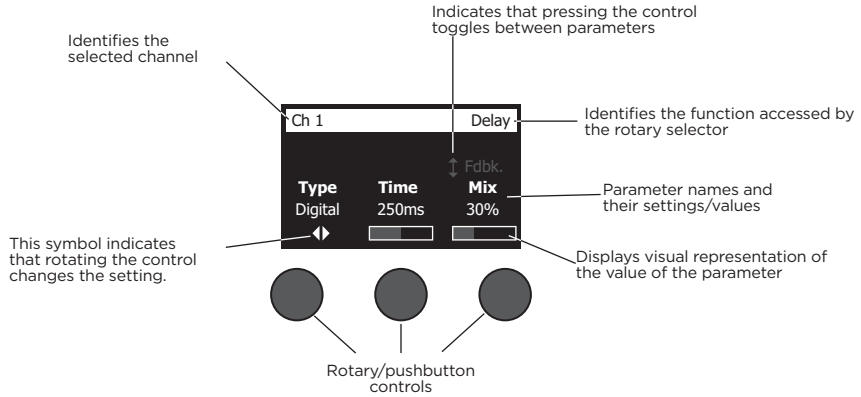

Optimizing Input Gain and Output Volume

Getting a quality volume level from your system relies on the combined adjustments of input channel gain, master volume, and channel volume. Do the following for each channel used.

1. Make sure the **Master** volume, **Trim**, and channel volume controls are set to minimum.
2. Adjust input channel **Trim**.
 - A. If applicable, adjust the volume of your instrument/source to the desired level.
 - B. Play your instrument/source at a performance level.
 - C. Slowly turn the **Trim** control clockwise until the signal/clip indicator glows green. If the indicator flashes red or glows steady red, turn the **Trim** control counterclockwise to decrease the level.
 - D. Use the input level meters (page 28) in the **Prefs** menu to check your input levels

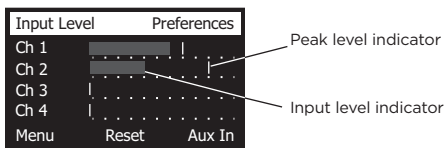

CAUTION: If you are using a device that requires phantom power (+48V), such as a condenser microphone, depress the **Phantom** power switch before adjusting the **Trim** control.

Note: The input level meter in the **Prefs** menu can be helpful when adjusting the input **Trim** level (see page 28).

3. Set the **Master** volume control at the 12 o'clock position.
4. Slowly turn the channel volume control clockwise until the volume reaches the desired level.

Operation

Using the Master Volume Control

The **Master** volume control adjusts the overall output level of the T4S/T8S ToneMatch® output and analog **Master** output. During normal operation, it is recommended to keep the **Master** control set at the 12 o'clock position. Once you have set volume levels for all channels, you can adjust the **Master** volume up or down from this position.

Muting a Channel

The **Mute** buttons silence the audio for the respective channel.

- To mute a channel, press the **Mute** button once. The **Mute** button glows white to indicate that the channel is muted. “CH MUTE” will appear on the display for the respective channel.

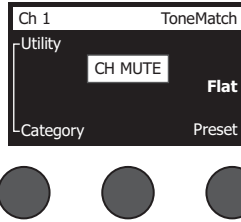

- Press the **Mute** button again to unmute the channel. The **Mute** button dims to indicate that the channel is not muted.

Muting Channel Effects

The **FX Mute** buttons mute only the Mod, Delay, and Reverb effects on the respective channel. Muting effects does not bypass ToneMatch presets, zEQ, Para EQ, and Comp/Gate settings.

- To mute effects on a channel, press the **FX Mute** button once. The **FX Mute** button glows white to indicate that the channel effects are muted. “FX MUTE” will appear on the display for the respective channel.

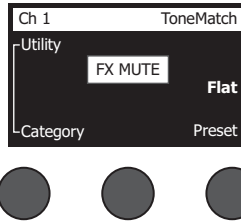

- Press the **FX Mute** button again to unmute the channel effects. The **FX Mute** button dims to indicate that the channel effects are not muted.

Using the Rotary Selector

The rotary selector provides access to the functions of the ToneMatch® mixer output. Figure 15 provides a summary of the nine channel-related functions and the three global functions. The following pages describe how to adjust each function.

Figure 15. Rotary selector

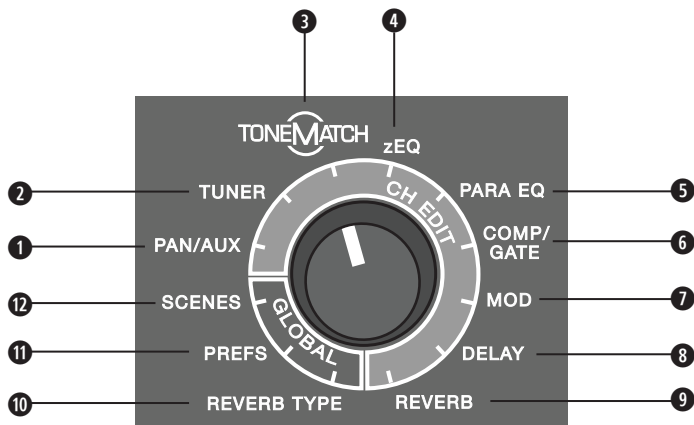

Channel Functions

- ❶ **Pan/Aux** – Provides access to pan, aux ins, and aux outs.
- ❷ **Tuner** – Provides tuning information for an instrument playing into the selected channel.
- ❸ **ToneMatch** – Provides access to proprietary ToneMatch presets designed for specific instruments and microphones.
- ❹ **zEQ** – As part of the selected ToneMatch preset, zEQ provides controls to adjust low/mid/high frequencies that are within the range of your instrument or microphone.
- ❺ **Para EQ** – Provides parametric EQ controls per channel.
- ❻ **Comp/Gate** – Provides access gate, compression, limiter, de-esser, and kick drum presets with adjustable parameters.
- ❼ **Mod** – Provides access to several modulation effects such as chorus, flanger, phaser, and tremolo.
- ❽ **Delay** – Provides access to three types of delays and tap-tempo delay.
- ❾ **Reverb** – Applies reverb to a selected channel and can be sent to mains or aux.

Global Functions

- ❿ **Reverb Type** – Applies a selected type of reverb to all master output channels or aux sends.
- ⓫ **Prefs** – Allows access to several system utilities.
- ⓬ **Scenes** – Allows you to save and load performance scenes (a snapshot of the complete state of the unit).

Operation

Editing the Sound of a Channel

The CH Edit functions allow access to settings that affect selected channels. The CH Edit functions are Pan/Aux, Tuner, ToneMatch®, zEQ, Para EQ, Comp/Gate, Mod, Delay, and Reverb.

To edit a channel:

1. Press the **CH Edit 1, 2, 3, 4**, (T4S and T8S) **5, 6, 7**, or **8** (T8S only) button. The selected channel will be viewable in the upper-left corner of the display.
2. Select one of the **CH Edit** functions using the rotary selector.
3. Adjust the settings for that function using the following instructions.

Note: You can only edit one channel at a time. Pressing a **CH Edit** button enables editing for the selected channel only.

Using the Pan/Aux Functions

Use the Pan/Aux function to route audio to either the master out L or R, control aux in, or aux send.

Using Pan

Use the Pan control to send each channel to its separate space in a stereo mix.

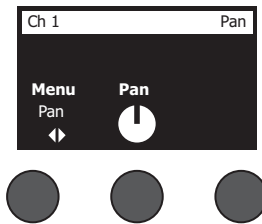

1. Press or rotate the left editor control and select Pan from the menu.
2. Rotate the **Pan** control to adjust the line output from L to R.

Aux Input 5/6 (9/10)

Use Aux Input 5/6 (9/10) to input a line-level stereo source, such as a mobile device.

1. Press or rotate the left control and select Aux In 5/6 from the menu.
2. Rotate the **5 Lvl** or **6 Lvl** control to adjust the signal level of either channel 5 or channel 6.
3. Press the **5 Lvl** to switch to **5 Pan**; press the **6 Lvl** control to switch to **6 Pan**. Rotate the **Pan** control to adjust the pan from L to R.

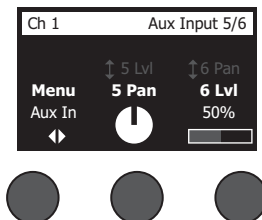

Routing Input Signals to the Aux Outputs

The Aux function allows you to route signals to two Aux outputs (T4S only) or four Aux outputs (T8S only) for various signal processing, recording, and sound reinforcement applications. The signal level is adjustable for each of the available Aux outputs:

Note: To mute the Aux output, press the **Level** control. Press it again to unmute.

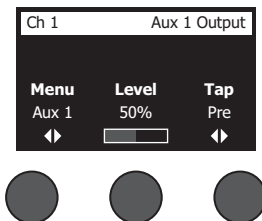

1. Press or rotate the **Menu** control and select an Aux Send.
2. Rotate the **Level** control to adjust the signal level of the selected channel.
3. Rotate the **Tap** control to scroll through the tap menu and highlight the desired tap point.
 - A. **Dry: After Preamp** - The completely dry (no processing) signal is routed directly from the preamp stage.
 - B. **Pre: With EQ & Fx** - The signal is routed from the preamp stage with applied processing.
 - C. **Post: After Fader** - The signal is routed after the Channel volume control with applied processing.
4. Press the **Select** control to select the tap point, or press the **Cancel** control to exit with no change. The name of the currently selected tap point appears in bold type.

Using the Tuner

An independent tuner is available on each input channel. The display indicates the note being played at the bottom of the screen. As you tune, a pitch indicator appears on the display, showing you whether the note is sharp or flat. Adjust the pitch of your instrument so the cursor aligns itself with the center of the screen.

Note: For silent tuning, press the **Mute** button for the applicable channel.

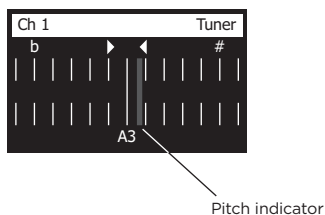

Use the Transpose feature to change the reference pitch up or down by two half steps. Or precisely dial in your tuning using the reference pitch.

Operation

Selecting a ToneMatch® Preset

The ToneMatch function allows you to select a ToneMatch preset for your instrument or microphone. This proprietary technology optimizes system equalization to preserve the natural sound of your specific instrument or microphone. They are organized into categories and independently selected for each channel.

1. Rotate the **Category** control to access the list of categories and highlight your choice.

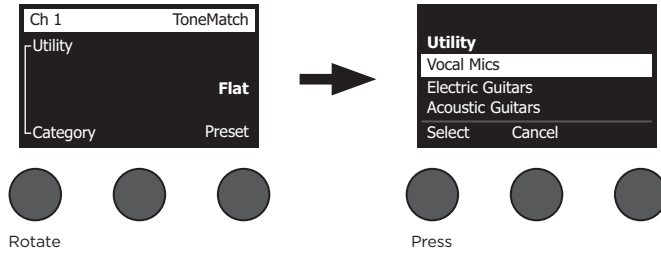

2. Press the **Select** control to select your choice, or press the **Cancel** control to exit the list with no change.
3. If you pressed **Select**, rotate the **Preset** control to access the list of presets and highlight your choice.
4. Press the **Select** control to select your choice, or press the **Cancel** control to exit the list with no change.

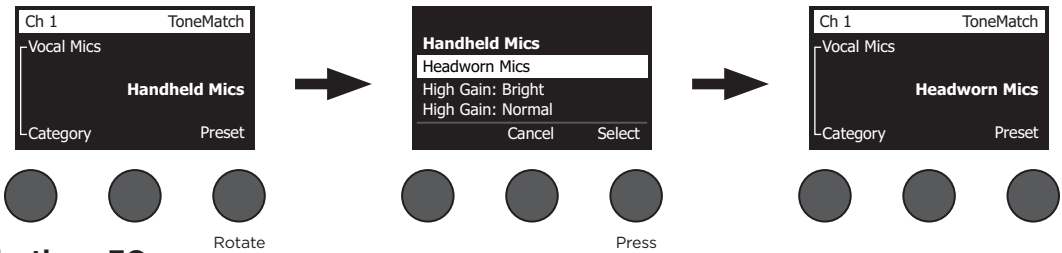

Adjusting zEQ

The zEQ function is part of the ToneMatch preset technology. It allows you to adjust low/mid/high frequencies that are within the range of your instrument or microphone.

To adjust zEQ, rotate the control under the corresponding frequency band.

Note: To bypass an individual frequency band, press the corresponding control. Press it again to activate.

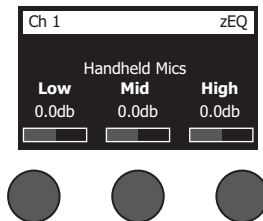

Adjusting Para EQ

The Para EQ function provides three parametric equalizations centered on a user-specified frequency within the range of 50 Hz to 16 kHz.

Note: To bypass the Para EQ settings, press the **Select** control. Press it again to activate.

1. Press or rotate the **Select** control and select Para EQ band 1-3.
2. Rotate the **Level** control to adjust the boost/cut level from -15 dB to +15 dB.
3. Rotate the **Freq** control to adjust the center frequency from 50 Hz to 16 kHz.
4. Press the **Freq** control to switch to Width. Rotate the **Width** control to adjust the width of the bell curve around the center frequency from 0.20 octave to 5.00 octave.

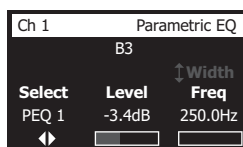

Using Compressor/Gate Functions

The Comp/Gate function provides access to gate, compression, limiter, de-esser and kick drum presets with adjustable parameters.

Note: To bypass the Comp/Gate settings, press the **Type** control. Press it again to activate.

Note: Only one effect per channel.

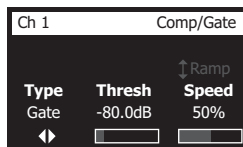

1. Rotate the **Type** control to access the list of Comp/Gate effects and highlight your choice:
 - A. Compressor 1: Light** – Compressor featuring a preset low-compression ratio with variable threshold and gain parameters. Works well as a general-purpose compressor for most instruments and microphones that require minimal level control.
 - B. Compressor 2: Medium** – Compressor featuring a preset moderate compression ratio with variable threshold and gain parameters. Works well with basses, guitars, keyboards, and vocals requiring subtle level control.
 - C. Compressor 3: Heavy** – Compressor featuring a preset high compression ratio with variable threshold and gain parameters. Works well with loud instruments (like horns and drums), as well as strong vocals that require more aggressive level control.
 - D. Limiter** – Hard limiter featuring a preset ratio (∞ :1) with variable threshold and gain parameters. Works well with very loud instruments, such as drums, to prevent signal peaks from overloading the channel.

Operation

- E. **De-Esser** – Side-chained compressor featuring a preset compression ratio with variable threshold and gain parameters. Designed to reduce sibilance on vocals.
 - F. **Noise Gate** – Noise gate with a fast preset attack time, variable threshold, and variable speed (release time). Well-suited for eliminating unwanted noise from microphones and instruments.
 - G. **KickGate 1: Regular** – Gate featuring a preset attack time, and variable threshold and tightness (release time) parameters. This is a Bose® proprietary technology designed specifically for kick drums. This robust gate provides maximum gain before feedback, making your kick drum as loud as possible through an PA system.
 - H. **KickGate 2: Fast** – Same as KickGate 1 but adjusted for faster tempos. Select this setting if you are using a double bass drum pedal.
2. Press the **Select** control to select your choice, or press the **Cancel** control to exit the list with no change.
 3. *Compressor 1-3, Limiter, De-Esser:* Rotate the **Thresh** control to adjust the input threshold (trigger) level from -50 dB to 0 dB. Rotate the **Gain** control to adjust the gain from 0 dB to 30.0 dB. The gain bar above the control shows the amount of gain reduction. This display helps in setting the threshold.
Noise Gate: Rotate the **Thresh** control to adjust the input threshold (trigger) level from -90 dB to -30 dB. Rotate the **Speed** control to set the gate closing speed to any value from 0% (fastest) to 100% (slowest). Rotate the **Ramp** control to adjust the slope of the gate from 0% (horizontal) to 100% (vertical).
KickGate 1-2: Rotate the **Thresh** control to adjust the input threshold (trigger) level from -20 dB to 0 dB. Rotate the **Tight** control to adjust the tightness (how quickly the gate closes) from 0% (slowest) to 100% (fastest).

Using the KickGate

The KickGate is a Bose® proprietary technology that allows you to raise the level of a kick drum channel while eliminating the risk of feedback from the microphone. Two KickGate settings are available in the Comp/Gate menu.

1. Connect the appropriate type of microphone.
2. Select an appropriate ToneMatch® preset.
3. Adjust the channel input **Trim** control until the hardest kick drum hits turn the input channel LED red, then continue to adjust the control until the LED turns green. This optimizes your channel input Trim level.
4. Select **Comp/Gate** with the rotary selector.
5. Rotate the **Type** control to scroll down the list, highlight **KickGate 1: Regular** or **KickGate 2: Fast**, and press **Select**. Choose KickGate 2 when using a double bass drum pedal.
6. While playing the kick drum, increase the volume to the desired performance level.
7. Play the kick drum at the softest level you intend to use in the performance and check that you can hear it.
8. While playing softly, increase the **Thresh** level until some of the kick drum hits get cut off. Then lower the **Thresh** level by 3 dB.
9. While playing the kick drum normally, rotate the **Tight** control counter-clockwise to reduce the tightness and add more “boom” to the sound. Tightness can be adjusted from 0% (slowest) to 100% (fastest).

Using Modulation Effects

The Mod function allows you to apply modulation effects.

Note: To bypass the Mod settings, press the **Type** control. Press it again to activate.

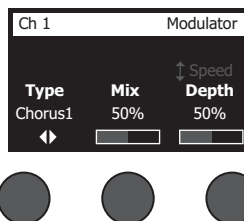

1. Rotate the **Type** control to access the list of modulator types and highlight your choice:
 - A. **Chorus 1: Brite** – Wet, shimmering chorus that works well with acoustic instruments. Includes adjustable mix, depth, and speed parameters.
 - B. **Chorus 2: Warm** – Similar to Chorus 1, but with a little less high frequencies. Includes adjustable mix, depth, and speed parameters. Works well with electric guitars/basses.
 - C. **Chorus 3: Dark** – Similar to Chorus 2, but with less high frequencies for a darker tone. Includes adjustable mix, depth, and speed parameters. Works well with electric guitars/basses.
 - D. **Flanger 1: Tape** – Tape-style flanger with no feedback. Includes adjustable mix, depth, and speed parameters. Works well as an effect on electric guitars/basses.
 - E. **Flanger 2: Feedback** – Same as Flanger 1, but with preset Feedback effect.
 - F. **Phaser 1: Stomp** – Classic “stompbox”-style phaser. Features a preset wide sweep with variable speed and feedback parameters. Works well as an effect on electric guitars/basses and keyboards.
 - G. **Phaser 2: Rack** – Classic “rack”-style phaser. Features a positive mix type with variable speed and feedback parameters. Works well as an effect on electric guitars/basses and keyboards.
 - H. **Phaser 3: Warm** – Vintage-style phaser. Features a positive mix type with variable speed and feedback parameters. Works well as an effect on electric guitars/basses and keyboards.
 - I. **Phaser 4: Brite** – Phaser with no bass. Features a positive mix type with variable speed and feedback parameters. Works well as an effect on electric guitars and keyboards.
 - J. **Tremolo** – Vintage-style tremolo effect with variable speed and depth parameters. Works well as an effect on guitars, keyboards, and harmonica.
2. Press the **Select** control to select your choice, or press the **Cancel** control to exit the list with no change.
3. *Chorus 1-3, Flanger 1-2:* Rotate the **Mix** control to adjust the desired mix of dry signal to wet signal (modulator-processed). Rotate the **Depth** control to adjust how much the pitch varies from the original input signal. Press the **Depth** control to access the **Speed** parameter. Rotate the **Speed** control to adjust how quickly the pitch modulates.
Phaser 1-4: Rotate the **Speed** control to adjust how quickly the pitch modulates. Rotate the **Fdbk.** control to adjust how much the modulation reverberates.
Tremolo: Rotate the **Speed** control to adjust how quickly the volume modulates. Rotate the **Depth** control to adjust how much the volume varies from the original input signal.

Operation

Adding Delays

The Delay function allows you to apply a digital-, analog-, or tape-style delay.

Note: To bypass the Delay settings, press the **Type** control. Press it again to activate.

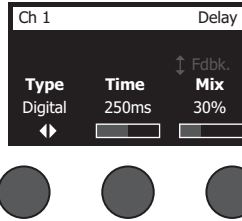

1. Rotate the **Type** control to access the list of Delay types and highlight your choice.
 - A. **Digital Delay** – Straight digital delay effect where the repeats remain uncolored. Features adjustable mix, time, and feedback parameters. Works well with guitars, drums, and vocals.
 - B. **Analog Delay** – Classic analog delay effect where the repeats continuously deteriorate. Features adjustable mix, time, and feedback parameters. Works well with guitars, drums, and vocals.
 - C. **Tape Delay** – Vintage-style tape delay effect where the repeats deteriorate even more than Analog Delay. Well-suited for guitars, horns, harmonica, and vocals.
2. Press the **Select** control to select your choice, or press the **Cancel** control to exit the list with no change.
3. Rotate the **Time** control to adjust the amount of the delay time in 5 ms increments. Press the **Time** control to tap your desired delay tempo.
4. Rotate the **Mix** control to set the desired mix of dry signal (0%) to wet signal (100%).
5. Press the **Mix** control to access the **Fdbk.** setting. Rotate the **Fdbk.** control to adjust the amount of delay feedback.

Adding Reverb

The Reverb function applies a user-adjustable amount of reverb to the selected channel. To select the type of reverb, see “Selecting a Reverb Type” on page 27.

Note: To mute the Reverb effects, press the **Mix** control. Press it again to unmute.

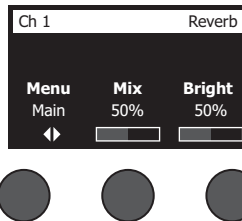

1. Press or rotate the **Menu** control and select which output to send the reverb too.
2. Rotate the **Mix** control to adjust the desired mix of dry signal (0%) to wet signal (100%).
3. Rotate the **Bright** control to equalize the high frequencies of reverb applied to the selected channel.

Using Global Functions

The **Global** functions allow access to settings that affect the overall operation of the mixer and all of its channels.

Selecting a Reverb Type

The Reverb Type function allows you to select the type of reverb that is applied to all input channels. The decay time (Time) and balance (Bal) are adjustable. Balance controls the ratio of early-to-late reflections.

Note: To mute the Reverb, press the **Type** control. Press it again to unmute.

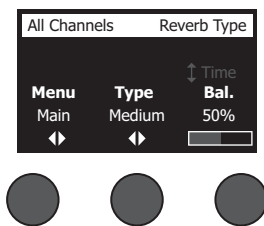

1. Select **Reverb Type** with the rotary selector.
2. Press or rotate the **Menu** control and select which output to send the reverb too. You can send a different reverb type to either the Main or Aux sends.
3. Rotate the **Type** control to display the list of reverbs:
 - A. **Plate** – Creates the ambiance of a typical studio plate reverb. Features adjustable time and balance (ratio of early/late reflections) parameters.
 - B. **Small** – Creates the ambiance of a small-sized space. Features adjustable time and balance (ratio of early/late reflections) parameters.
 - C. **Medium** – Creates the ambiance of a medium-sized space. Features adjustable time and balance (ratio of early/late reflections) parameters.
 - D. **Large** – Creates the ambiance of a large-sized space. Features adjustable time and balance (ratio of early/late reflections) parameters.
 - E. **Cavern** – Creates the ambiance of an extremely large space. Features adjustable time and balance (ratio of early/late reflections) parameters. A unique and interesting reverb effect.
4. Rotate the **Type** control to scroll through the reverb list and highlight the desired reverb type.
5. Press the **Type** control to select.
6. Rotating the **Time** control controls the decay time of the selected reverb model from its minimum decay time to its maximum decay time. At 0%, the decay time will be at minimum and will simulate the smallest room size available to the currently selected reverb type. At 100%, the decay time will be at maximum and will simulate the largest room size available to the currently selected reverb type. Each reverb type has their own usable range of decay times that work best for the selected model type. The Reverb Decay parameter allows you to adjust the reverb time between the specific ranges that work best for the selected reverb model type.
7. Press the **Time** control to switch to **Bal.** Rotate the **Bal.** control to adjust the early-to-late reflection ratio (0% = all early reflections, 100% = all late reflections).

Operation

Using the Prefs Utilities

The Prefs function allows access to several system utilities.

1. Select **Prefs** with the rotary selector.
2. Rotate the **Menu** control to scroll through the list and highlight the desired utility. Press the **Select** control to display the utility:
 - **Status** - Displays the effects assigned to input channels (viewable only).

Status	Preferences
Ch 1	Cmp Mod Rev
Ch 2	Cmp Mod Rev
Ch 3	Mod Dly Rev
Ch 4	Rev
Menu	

Cmp = Compressor/Gate

Mod = Modulation

Dly = Delay

Rev = Reverb



- **Input Level** - Displays input level meters with peak signal indicators for all input channels. Press the **Reset** control to reset all peak signal indicators. This display is helpful in setting the channel input trim level (see “Optimizing Input Gain and Output Volume” on page 17). Press the **Aux In** control to monitor the level of the auxiliary inputs (For the T8S only, press the Ch 5-8 control to monitor the level of Inputs 5-8).

Input Level	Preferences
Ch 1	
Ch 2	
Ch 3	
Ch 4	
Menu	Reset Aux In

Peak level indicator

Input level indicator



- **Output Level** - Displays output level meters for all outputs: Main L, Main R, USB L, and USB R. Press the **Aux** control to monitor the level of the auxiliary outputs.

Output Level	Preferences
Main L	
Main R	
USB L	
USB R	
Menu	Reset Aux



- **Master Out EQ** – The Master Out EQ is a 6-band graphic equalizer put on the master mix output. With the middle control, select the frequency range you want to boost or attenuate and use the **Level** control to adjust the level +/-18 dB.

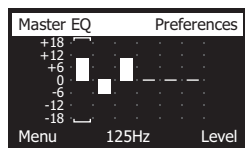

- **USB B to PC** – Allows you to send a selected source to your computer through USB left and right output channels. The source choices are Ch1-4 (Ch5-8 for T8S only), Aux In, Master, or Aux Out 1-2 (Aux Out 3-4 for T8S only).

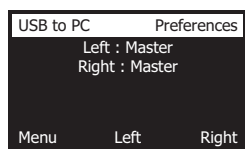

1. Rotate the **Left/Right** control to highlight a source.
2. Press the **Select** control to select the source, or press the **Cancel** control to exit with no change.
3. Rotate **Menu** to return to the Prefs menu list.

- **USB B from PC** – Allows you to send USB left and right channels from your computer to a selected mixer destination (None, Aux In, or Master).

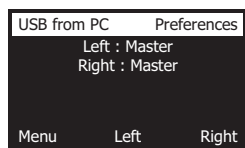

1. Rotate the **Left/Right** control to highlight a destination.
2. Press the **Select** control to select the source, or press the **Cancel** control to exit with no change.
3. Rotate the **Menu** control to return to the Prefs menu list.

- **USB A-Playback** – Attach a USB Type-A flash drive to play any WAV/MP3 files stored to the flash drive. Using the menu, select the folder that contains the WAV/MP3 files; select the file you want to play and adjust the level by rotating the **Level** control.

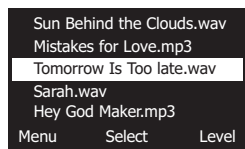

Operation

- **Versions** – Displays revision levels of DSP Firmware.

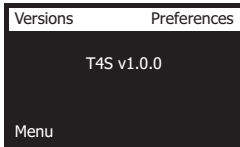

- **ToneMatch** – Displays the list of ToneMatch preset banks stored in the T4S/T8S. Refer to bosepro.link/tmu for the latest preset banks.

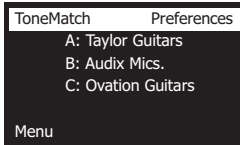

- **L1 Power Stand** – When connected to an L1* Model 1S/II power stand, **Connected** appears on the screen.

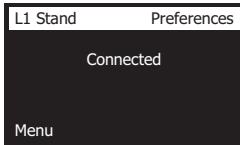

Loading and Saving Scenes

A scene is a snapshot of the state of the T4S/T8S ToneMatch® mixer.

- A scene remembers all ToneMatch mixer settings, and the status of the **Mute**, **FX Mute**, and **CH Edit** buttons.
- A scene does not remember channel trim, channel volume levels, Master volume level, headphone level or the Phantom power switch position.

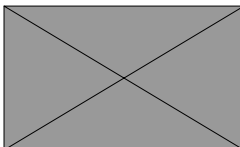

The T4S/T8S includes three types of scenes:

- (5) Bose scenes: Read-only factory-preset scenes. You cannot edit and overwrite them.
- (10) User Scenes: User-definable scenes for saving and recalling all your favorite settings. You can update these scenes by overwriting them as many times as you want.
- (1) Shared Scene: A user-definable scene for saving settings you want to share with other T4S/T8S ToneMatch® mixer users. This scene can be uploaded to a computer using the ToneMatch Updater software available at bosepro.link/tmu.

To load a scene:

1. Select **Scenes** with the rotary selector.
2. Rotate the **Load** control to scroll through the scenes list and highlight the desired scene name. The name of the currently loaded scene appears in bold type.
3. Press the **Select** control to select the scene, or press the **Cancel** control to exit the list and leave the setting unchanged.

Note: The display returns to the Scenes screen if you do not press the **Select** or **Cancel** control within 10 seconds. No change is made and the currently loaded scene appears on the screen.

4. If you pressed Select, the question “Are you sure?” is displayed. Press the **Yes** control to load the scene, or press the **No** control to exit and leave the scene setting unchanged.

Note: The display returns to the Scenes screen if you do not press the **Yes** or **No** control within 10 seconds. No change is made and the currently loaded scene appears on the screen.

To save a scene:

1. Select **Scenes** with the rotary selector. The currently loaded scene is displayed.

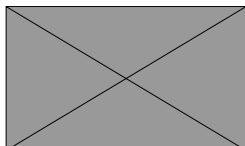

2. Rotate the **Save** control to highlight the scene you wish to save. Press **Select**, or press **Cancel** to exit the list.

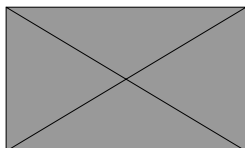

Note: The display returns to the Scenes screen if you do not press the **Select** or **Cancel** control within 10 seconds. No change occurs, and the currently loaded scene appears on the screen.

Operation

- If you pressed **Select**, use the Rename screen to edit the scene name, or press **Save** to use the name as displayed and go to Step 4.

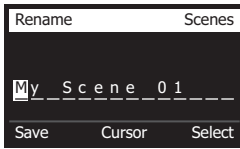

To change the scene name before saving:

You can use the following editing options to change the scene name. After changing the name, press the Save control and go to Step 4.

- Select and change characters:** While the Rename screen is displayed, rotate the **Cursor** control to highlight the character or character position you want to change. Then rotate the **Select** control to change the character.
- Use the character map:** While the Rename screen is displayed, rotate the **Cursor** control to highlight the character you want to change. Then press the **Select** control to view the character map. Rotate the **Select** control to move the cursor left or right. Rotate the **Up/Dn** control to move the cursor up or down. When the character you want is highlighted, press **Select** to write that character in the selected position.

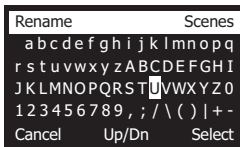

- Use clear, insert, and delete functions:** While the Rename screen is displayed, rotate the **Cursor** control to position the cursor. Then press the **Cursor** control for a menu of special editing functions. Rotate the **Select** control to highlight the function you want. Then press the **Select** control to perform the function.

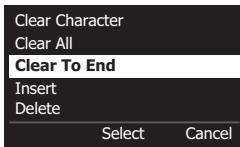

Clear Character - Removes the character highlighted by the cursor and leaves a blank space.

Clear All - Clears the entire line of text.

Clear to End - Clears all text to the right of the cursor including the highlighted character.

Insert - Inserts a blank space to the left of the highlighted character.

Delete - Removes the character and space highlighted by the cursor.

- When the question “Are You Sure?” is displayed, press the **Yes** control to save the scene, or press the **No** control to exit without saving the scene.



Sharing a Scene

If you create a scene that you would like to share with another T4S/T8S ToneMatch® mixer user, you can save that scene as a Shared Scene by saving it to the **[To Shared Scene]** slot. Using the ToneMatch Updater, you can upload the Shared Scene to your computer and then transfer the file to the computer of another T4S/T8S user. The other T4S/T8S user can download the scene to their T4S/T8S using the ToneMatch Updater. The ToneMatch Updater is available at bosepro.link/tmu.

To save a Shared Scene:

- Load the scene that you want to share (see “To load a scene” on page 31).
- Press the **Save** control to access the list of scenes.
- Rotate the **Select** control to scroll through the scene list and highlight **[To Shared Scene]**. Press **Select** or press **Cancel** to exit the list.

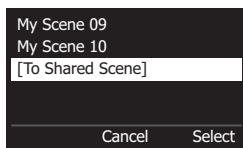

Note: The display returns to the Scenes screen if you do not press the **Select** or **Cancel** control within 10 seconds. No change occurs, and the currently loaded scene appears on the screen.



- If you pressed **Select**, use the Rename screen to edit the scene name (see “To change the scene name before saving” on page 32) or go to Step 5 if you want to use the existing name.

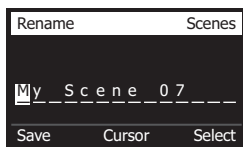

Operation

5. Press the **Save** control to store the scene as a Shared Scene.
6. When the question “Are you sure?” is displayed, press the **Yes** control to save the scene, or press the **No** control to exit without saving the scene as a Shared Scene.

Note: The display returns to the Scenes screen if you do not press the **Yes** or **No** control within 10 seconds. No change occurs, and the currently loaded scene appears on the screen.

7. Press the **Shared** control to confirm the scene saved as a Shared Scene.



Note: The T4S/T8S provides only one storage location for a Shared Scene. Saving a scene as a Shared Scene always overwrites the previously saved Shared Scene.

Please visit [bosepro.link/tmu](https://www.bosepro.link/tmu) for details on using the ToneMatch Updater application for downloading and uploading scenes to and from your computer.

Bose Scenes

The five Bose scenes are provided as examples for you to use as a starting point. After loading a Bose scene, you can modify the settings and then save the settings as a My Scene or Shared Scene.

Factory Settings

This scene restores the mixer to the settings it had when it left the factory. Loading this scene erases any changes you previously made to the currently loaded scene.

	CH 1-4 (T4S/T8S)	CH 5-8 (T8S)	
ToneMatch	Active		
	Utility		
	Flat		
zEQ	Bypass		
	Low	Mid	High
	0 dB	0 dB	0 dB
Para EQ	Bypass		
Comp/Gate	Bypass		
	Chorus1		
Mod	Bypass		
	Chorus1		
Delay	Bypass		
	Digital		
Reverb	Bypass		
	Digital		
Aux	Mute		
	Pre: With EQ & Fx		

Global Settings	
Preferences	
Active screen	Status
USB to PC	Left/Right:Master
USB from PC	Left/Right:Master
Master Out	Post Master Volume
Reverb Type	
Type	Medium
Time	50%
Bal	50%

Note: For a list of the factory settings for all effects, see “Factory Settings” on page 42.

Operation

Singer/Songwriter

This scene is designed for a singer/songwriter playing keyboard or guitar and sometimes accompanied by an MP3 track.

Figure 16. Example setup for Singer/Songwriter

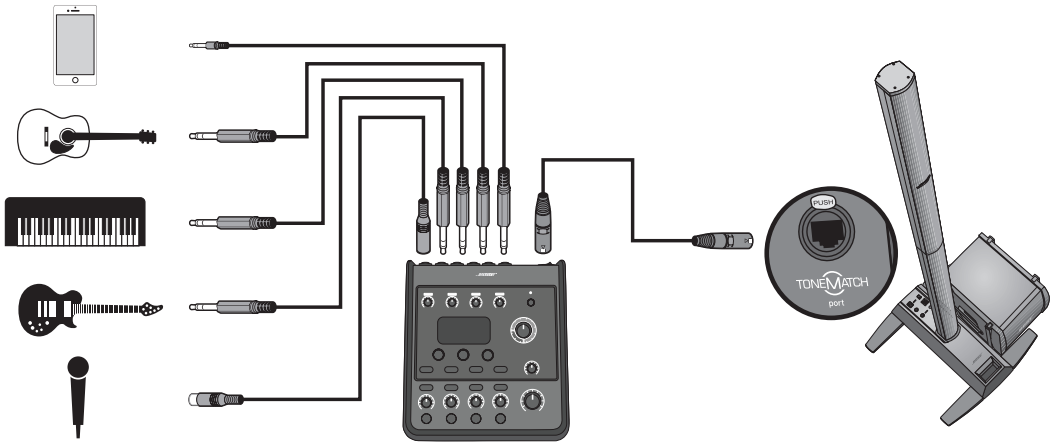

Singer/Songwriter scene channel settings

	Microphone	Guitar	Keyboard	Bass	Aux In
	CH 1	CH 2	CH 3	CH 4	5/6
ToneMatch	Active Vocal Mics Handheld Mics	Active Acoustic Guitar Steel String w/ piezo	Active Keyboards General Keys	Active Basses Active Bass 1	N/A
zEQ	Active Low Mid High 0 dB 0 dB 0 dB	Active Low Mid High 0 dB 0 dB 0 dB	Active Low Mid High 0 dB 0 dB 0 dB	Active Low Mid High 0 dB 0 dB 0 dB	N/A
Para EQ	Bypass	Bypass	Bypass	Bypass	N/A
Comp/ Gate	Bypass Comp2	Bypass Comp2	Bypass Comp2	Bypass Comp2	N/A
Mod	Bypass Chorus1	Bypass Chorus1	Bypass Chorus3	Bypass Chorus1	N/A
Delay	Bypass Digital	Bypass Digital	Bypass Digital	Bypass Digital	N/A
Reverb	Active Medium (Global)	Active Medium (Global)	Active Medium (Global)	Active Medium (Global)	N/A
Pan/Aux	Center Aux 1-2 Pre: With EQ & Fx	Center Aux 1-2 Pre: With EQ & Fx	Center Aux 1-2 Pre: With EQ & Fx	Center Aux 1-2 Pre: With EQ & Fx	Aux In 5 Lvl 6 Lvl 50% 50%

Global Settings

Preferences	Active screen	Status
	USB to PC	Left/Right:Master
	USB from PC	Left/Right:Master
	Master Out	Post Master Volume
Reverb Type		
	Type	Medium
	Time	50%
	Bal	50%

Operation

DJ/Playback

The DJ/Playback scene is designed for a DJ event or any audio playback need. This setup uses two microphones and either a mobile device, mixer, or laptop computer.

Figure 17. Example setup for stereo DJ/Playback

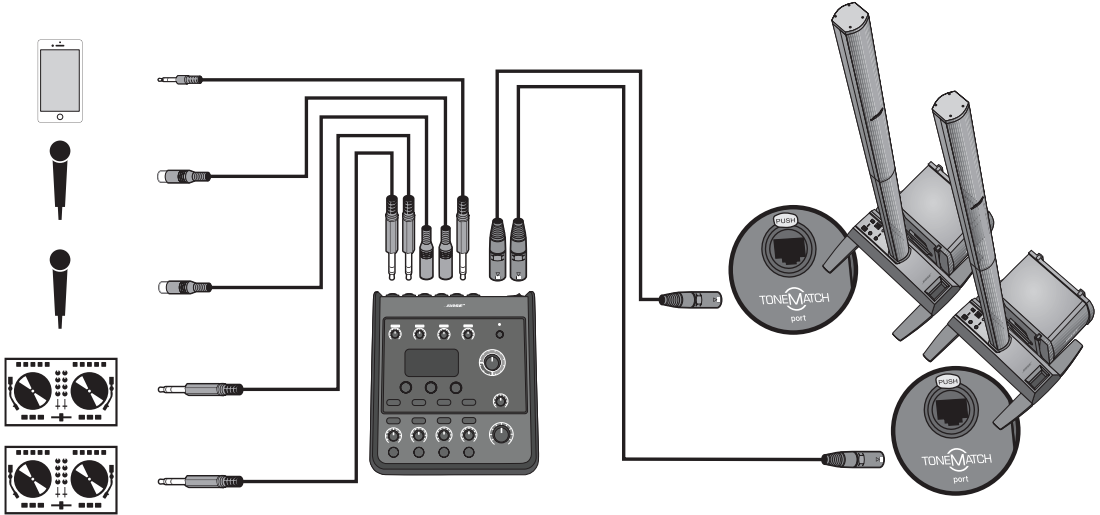

DJ/Playback scene channel settings

	Source 1 Left	Source 1 Right	Microphone	Microphone	Aux In
	CH 1	CH 2	CH 3	CH 4	5/6
ToneMatch	Active DJ/Playback Flat, zEQ Controls	Active DJ/Playback Flat, zEQ Controls	Active Vocal Mics Handheld Mics	Active Vocal Mics Handheld Mics	N/A
zEQ	Active Low Mid High 0 dB 0 dB 0 dB	Active Low Mid High 0 dB 0 dB 0 dB	Active Low Mid High 0 dB 0 dB 0 dB	Active Low Mid High 0 dB 0 dB 0 dB	N/A
Para EQ	Bypass	Bypass	Bypass	Bypass	N/A
Comp/Gate	Bypass Limit	Bypass Limit	Bypass Comp2	Bypass Comp2	N/A
Mod	Bypass Chorus1	Bypass Chorus1	Bypass Chorus3	Bypass Chorus1	N/A
Delay	Bypass Digital	Bypass Digital	Bypass Digital	Bypass Digital	N/A
Reverb	Bypass Medium (Global)	Bypass Medium (Global)	Bypass Medium (Global)	Bypass Medium (Global)	N/A
Pan/Aux	Left Aux 1-2 50% Pre: With EQ & Fx	Right Aux 1-2 50% Pre: With EQ & Fx	Center Aux 1-2 50% Pre: With EQ & Fx	Center Aux 1-2 50% Pre: With EQ & Fx	Aux In 5 Lvl 6 Lvl 50% 50%

Global Settings

Preferences	
Active screen	Status
USB to PC	Left/Right:Master
USB from PC	Left/Right:Master
Master Out	Post Master Volume
Reverb Type	
Type	Medium
Time	50%
Bal	50%

Operation

Full Band

This scene is set up for a drum kit, bass guitar, electric guitar, vocals, and MP3 player.

Figure 18. Example setup for Drums and Bass

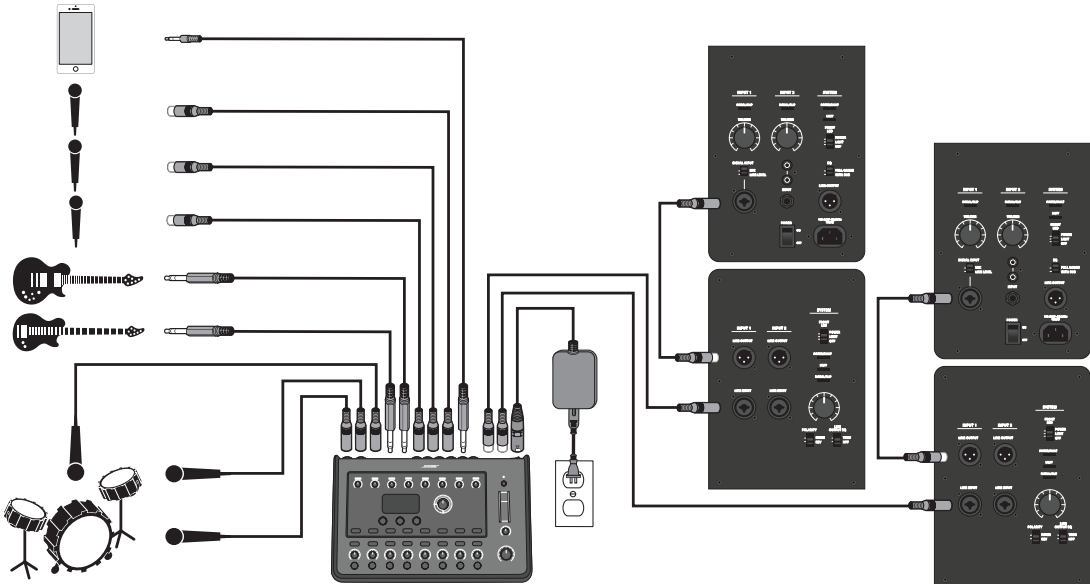

Full Band scene channel settings

	Kick Drum		Overhead		Overhead		Bass		Guitar		Microphone		Microphone		Microphone		Aux In
	CH 1	CH 2	CH 3	CH 4	CH 5	CH 6	CH 7	CH 8	CH 9	CH 10	CH 11	CH 12	CH 13	CH 14	CH 15	CH 16	9/10
ToneMatch	Active Percussion Kick, General	Active Percussion General Overhead	Active Percussion General Overhead	Active Basses Active Bass1	Active Electric Guitars Midi Amp w/ SM57	Active Vocal Mics Handheld Mics	Active Vocal Mics Handheld Mics	Active Vocal Mics Handheld Mics	Active Vocal Mics Handheld Mics	Active Vocal Mics Handheld Mics	Active Vocal Mics Handheld Mics	Active Vocal Mics Handheld Mics	Active Vocal Mics Handheld Mics	Active Vocal Mics Handheld Mics	Active Vocal Mics Handheld Mics	Active Vocal Mics Handheld Mics	N/A
zEQ	L M H 0 0 0 dB dB dB	L M H 0 0 0 dB dB dB	L M H 0 0 0 dB dB dB	L M H 0 0 0 dB dB dB	L M H 0 0 0 dB dB dB	L M H 0 0 0 dB dB dB	L M H 0 0 0 dB dB dB	L M H 0 0 0 dB dB dB	L M H 0 0 0 dB dB dB	L M H 0 0 0 dB dB dB	L M H 0 0 0 dB dB dB	L M H 0 0 0 dB dB dB	L M H 0 0 0 dB dB dB	L M H 0 0 0 dB dB dB	L M H 0 0 0 dB dB dB	L M H 0 0 0 dB dB dB	N/A
Para EQ	Bypass	Bypass	Bypass	Bypass	Bypass	Bypass	Bypass	Bypass	Bypass	Bypass	Bypass	Bypass	Bypass	Bypass	Bypass	Bypass	N/A
Comp/Gate	Active Kick1	Bypass Comp2	Bypass Comp2	Active Comp2	Bypass Comp2	Bypass Comp2	Bypass Comp2	Bypass Comp2	Bypass Comp2	Bypass Comp2	Bypass Comp2	Bypass Comp2	Bypass Comp2	Bypass Comp2	Bypass Comp2	Bypass Comp2	N/A
Mod	Bypass Chorus1	Bypass Chorus1	Bypass Chorus1	Bypass Chorus1	Active Chorus1	Bypass Chorus1	Bypass Chorus1	Bypass Chorus1	Bypass Chorus1	Bypass Chorus1	Bypass Chorus1	Bypass Chorus1	Bypass Chorus1	Bypass Chorus1	Bypass Chorus1	Bypass Chorus1	N/A
Delay	Bypass Digital	Bypass Digital	Bypass Digital	Bypass Digital	Bypass Digital	Bypass Digital	Bypass Digital	Bypass Digital	Bypass Digital	Bypass Digital	Bypass Digital	Bypass Digital	Bypass Digital	Bypass Digital	Bypass Digital	Bypass Digital	N/A
Reverb	Bypass Medium (Global)	Bypass Medium (Global)	Bypass Medium (Global)	Bypass Medium (Global)	Bypass Medium (Global)	Bypass Medium (Global)	Bypass Medium (Global)	Bypass Medium (Global)	Bypass Medium (Global)	Bypass Medium (Global)	Bypass Medium (Global)	Bypass Medium (Global)	Bypass Medium (Global)	Bypass Medium (Global)	Bypass Medium (Global)	Bypass Medium (Global)	N/A
Pan/Aux	Center Aux1-4 Dry: After Preamp	Center Aux1-4 Dry: After Preamp	Center Aux1-4 Dry: After Preamp	Center Aux1-4 Dry: After Preamp	Center Aux1-4 Dry: After Preamp	Center Aux1-4 Dry: After Preamp	Center Aux1-4 Dry: After Preamp	Center Aux1-4 Dry: After Preamp	Center Aux1-4 Dry: After Preamp	Center Aux1-4 Dry: After Preamp	Center Aux1-4 Dry: After Preamp	Center Aux1-4 Dry: After Preamp	Center Aux1-4 Dry: After Preamp	Center Aux1-4 Dry: After Preamp	Center Aux1-4 Dry: After Preamp	Center Aux1-4 Dry: After Preamp	Aux In 9 Lvl 10 Lvl 50% 50%

Global Settings

Preferences	
Active screen	Status
USB to PC	Left/Right:Master
USB from PC	Left/Right:Master
Master Out	Post Master Volume
Reverb Type	
Type	Medium
Time	50%
Bal	50%

Factory Settings

Factory Settings

This section describes the settings in the T4S/T8S mixer when it left the factory. To restore your T4S/T8S at any time to these factory settings, load the Bose Factory Settings scene.

Comp/Gate Factory Settings

Type	Thresh	Gain
Compressor 1: Light	-16.0 dB	3.0 dB
Compressor 2: Medium	-16.0 dB	5.0 dB
Compressor 3: Heavy	-16.0 dB	8.0 dB
Limiter	-10.0 dB	0 dB
De-Esser	-10.0 dB	0 dB
Thresh		Speed
Noise Gate	-70.0 dB	50%
Thresh		Tight
KickGate1: Regular	-20.0 dB	100%
KickGate2: Fast	-20.0 dB	100%

Modulator Factory Settings

Type	Thresh	Gain	Speed
Chorus 1: Brite	50%	50%	0.50 Hz
Chorus 2: Warm	70%	100%	0.15 Hz
Chorus 3: Dark	25%	25%	3.0 Hz
Flanger 1: Tape	50%	50%	1.00 Hz
Flanger 2: Feedback	50%	100%	2.00 Hz
Speed		Feedback	
Phaser 1: Stomp	0.50 Hz	0%	
Phaser 1: Rack	0.50 Hz	-75%	
Phaser 1: Warm	1.00 Hz	-26%	
Phaser 1: Bright	0.50 Hz	-76%	
Speed		Depth	
Tremolo	5.00 Hz	50%	

Delay Factory Settings

Type	Mix	Time	Feedback
Digital	30%	150 ms	30%
Analog	30%	275 ms	20%
Tape	30%	350 ms	30%

Reverb Type Factory Settings

Type	Bal.	Time	Time Range
Plate	50%	20%	0-4.6 s
Small	50%	15%	0-0.8 s
Medium	50%	25%	0-1.9 s
Large	50%	50%	0-3.5 s
Cavern	50%	100%	0-7.0 s

Troubleshooting

If you experience problems while using this product, try the following solutions. If you still cannot solve the problem, seek online help at [bosepro.link/tmu](https://www.bosepro.link/tmu). If you cannot find answers to your questions there, please call the Bose Product and Technical Support Team directly at (877) 335-2673.

Problem	What to do
T4S/T8S is plugged in, power switch is on, but no power.	<ul style="list-style-type: none"> • Make sure you have power at the AC outlet. Try operating a lamp or other equipment from the same AC outlet or test the outlet using an AC outlet tester. <p>If using the T4S with an L1® Model II or 1S system:</p> <ul style="list-style-type: none"> • Make sure the ToneMatch® cable is properly connected to the mixer and the L1 power stand. • Verify that the power cord plug is fully inserted into the power stand and the AC (mains) outlet. • Make sure the L1 power stand is turned on and the power LED is blue.
T4S/T8S is on, but there is no sound.	<ul style="list-style-type: none"> • Make sure the Master volume control is turned up. • Verify that the input channel(s) you want to hear is not muted. • Check that the Volume control is turned up for the channel you want to hear. • Make sure the appropriate input channel Trim control has been turned up enough so that the LED is green (indicating that there is a strong input signal). • Check the Prefs (Preference) Input and Output level meters to confirm that there is a signal at both the input and output stages. • Make sure volume control is turned up on your input source (instrument). • Connect your input source (instrument) to the mixer using a different cable. • Plug your input source (instrument) directly into the L1 power stand or a different amplifier to make sure the source is working. • Turn the mixer off and wait 30 seconds. Then turn mixer on again. <p>If using the T4S with an L1 Model II or 1S system:</p> <ul style="list-style-type: none"> • Turn off the power stand, re-seat the ToneMatch cable plug in the ToneMatch port, and turn on the power stand again. • If available, try a different ToneMatch cable. If another ToneMatch cable is not available, try a standard ethernet cable. • Connect the T4S/T8S Master output to the Analog Input on the power stand using a ¼" phone plug cable. Turn up the power stand Trim control, and verify that you hear sound. • Make sure power LED on power stand is blue. If LED is red, please call the Bose Product and Technical Support Team directly at (877) 335-2673.

Care and Maintenance

Problem	What to do
<p>Poor quality sound from a microphone or instrument connected to the T4S/T8S.</p>	<ul style="list-style-type: none"> • Make sure there is no unwanted zEQ or Para EQ equalization applied. • Verify that you have selected an appropriate ToneMatch® mixer preset for your microphone/instrument. If you do not want to use a ToneMatch mixer preset, make sure ToneMatch is set to Flat. • Make sure there are no unwanted effects (Comp/Gate, Mod, Delay, Reverb) on your input channel. Check the Status in the Prefs menu for any currently active effects. • Check that the T4S/T8S input Trim is adjusted properly for your microphone/instrument. The signal LED should be green; if the LED is red, lower the Trim level until it is green. • Try a different microphone or instrument cable. • Check the cable connecting your microphone or instrument to the T4S/T8S mixer. Make sure the cable plug is fully inserted into the microphone/instrument output connector and the T4S/T8S input connector. • Check the settings (if any) on your microphone or instrument. • Check the batteries (if any) in your instrument or microphone.
<p>Not hearing any effects.</p>	<ul style="list-style-type: none"> • Check that you pressed the correct CH Edit button. • Make sure the FX Mute button is not pressed for the channel in question.
<p>T4S/T8S not responding to control knobs.</p>	<ul style="list-style-type: none"> • Turn off the mixer. Wait 30 seconds and turn mixer on again.
<p>Master volume control has no effect.</p>	<ul style="list-style-type: none"> • Verify that the Master output is configured for Post Master Volume operation in the Prefs menu under Master Out.
<p>With nothing plugged into the T4S/T8S input connectors, a slight hum or buzz is heard from the L1® system.</p>	<ul style="list-style-type: none"> • Plug the T4S/T8S and the L1 power stand into the same AC (mains) outlet. • Using an AC outlet tester, test the AC outlet that the T4S/T8S and/or the L1 power stand is plugged into for reversed or open (hot, neutral, and/or ground) contacts. • If using an extension cord, make sure that the cord is also tested as above.
<p>Too much (or not enough) bass, mid-range, or high frequencies.</p>	<ul style="list-style-type: none"> • Make sure there is no unwanted zEQ or Para EQ equalization applied. • Verify that you have selected an appropriate ToneMatch mixer preset for your microphone/instrument. If you do not want to use a ToneMatch mixer preset, make sure ToneMatch is set to Flat in the Utility category.
<p>Poor-sounding playback of a stereo recording using a CD player, MP3 player, or other such device.</p>	<ul style="list-style-type: none"> • Connect the left channel of the device to Aux input 5 and the right channel to Aux input 6 (or 9/10 for T8S). Aux inputs 5/6 (or 9/10) are designed for line-level inputs. • Disable any extended bass or EQ features when using CD or mobile device. • If you are using recording software on a computer, check the software requirements. You may need to configure the software settings for 48 kHz/24-bit operation.

Problem	What to do
<p>Microphone is encountering feedback.</p>	<ul style="list-style-type: none"> • Orient the microphone so that it is not pointing directly at its respective loudspeaker. • Try a different microphone. • Try a different position for the L1 system and/or vocalist on stage. • Increase the distance from the L1 system to the microphone. • Reduce the HIGH frequencies by adjusting the zEQ on the microphone channel. • Try notching out a particular frequency that could be causing the feedback by adjusting the Para EQ on the microphone channel. • Temporarily bypass any audio effects used (Mod, Delay, Reverb) to see if they might be contributing to the feed-back problem.
<p>Aux output does not sound right.</p>	<ul style="list-style-type: none"> • Check if the Aux output is configured for the desired tap point for each input channel. Refer to “Routing Input Signals to the Aux Output” on page 21. • Verify that each input assigns the desired signal level to the Aux output.
<p>Unable to send T4S/T8S audio to a computer through a USB connection.</p>	<ul style="list-style-type: none"> • Check that the USB cable is properly connected to the mixer and computer. • Try a different USB cable. • Make sure the mixer is turned on. • Verify that the desired mixer input channels are assigned to the left and right USB output channels. See “USB to PC” in the Prefs menu. • Make sure that the Trim level of the respective input channel is turned up enough so that the green LED is on, indicating that there is a strong input signal. • Check the Input and Output level meters under the Prefs menu to confirm that there is a signal at both the input and output stages. • Verify that your computer USB input is working by connecting another USB-compatible audio device. • If you are using recording software on a computer, check the software requirements. You may need to configure the software settings for 48 kHz/24-bit operation.
<p>T4S/T8S is not responding to flash drive.</p>	<ul style="list-style-type: none"> • To determine if there is an issue with your flash drive, connect a different brand flash drive

Care and Maintenance

Problem	What to do
Unable to send audio from a computer to the T4S/T8S via USB connection.	<ul style="list-style-type: none">• Check that the USB cable is properly connected to the mixer and computer.• Try a different USB cable.• Make sure mixer is turned on.• Verify the computer is playing and that the audio setting is not disabled in your computer.• Check that the USB signal is assigned to the desired mixer inputs. See “PC to USB” in the Prefs menu.• Verify that the mixer input channels assigned to the incoming USB signal are not muted and their volume controls are turned up.• Make sure that the appropriate input channel Trim control is turned up enough so that the green LED is on (indicating that there is a strong input signal).• Check the Input and Output level meters under the Prefs menu to confirm that there is a signal at both the input and output stages.• Verify that your computer USB output is working by connecting another USB-compatible audio device.• If you are using recording software on a computer, check the software requirements. You may need to configure the software settings for 48 kHz/24-bit operation.

Cleaning

- You may clean the product enclosure using only a soft dry cloth.
- Do not use any solvents, chemicals, or cleaning solutions containing alcohol, ammonia, or abrasives.
- Do not use any sprays near the product or allow liquids to spill into any openings.

Technical Information

Mechanical		
	T4S	T8S
Dimensions (L x W x H)	8.4" x 7.25" x 3.25" (214 mm x 184 mm x 83 mm)	8.4" x 12.25" x 3.25" (214 mm x 311 mm x 83 mm)
Weight	2.1 lbs (1.0 kg)	4.1 lbs (1.9 kg)
Electrical		
A/D and D/A Conversion	24 bits	
Sampling Rate	48 kHz	
USB	2.0 or higher, Type-A to Type-B cable, Type-A port and Type-B port	
PC Requirements	Microsoft Windows 7 or higher; Mac OS 10.5 or higher	

Contact Information

Visit us on the web at www.Bose.com.

Americas

(USA, Canada, Mexico, Central America, South America)
Bose Corporation
Frammingham, MA 01701 USA
Corporate Center: 508-879-7330
Americas Professional Systems,
Technical Support: 800-994-2673

Australia

Bose Pty Limited
Unit 3/2 Holker Street
Newington NSW Australia
61 2 8737 9999

Belgium

Bose N.V. / S.A
Limesweg 2, 03700
Tongerren, Belgium
012-390800

China

Bose Electronics (Shanghai) Co Ltd
25F, L'Avenue
99 Xianxia Road
Shanghai, P.R.C. 200051 China
86 21 6010 3800

France

Bose S.A.S
26-28 avenue de Winchester
78100 St. Germain en Laye, France
01-30-61-63-63

Germany

Bose GmbH
Max-Planck Strasse 36D 61381
Friedrichsdorf, Deutschland
06172-7104-0

Hong Kong

Bose Limited
Suites 2101-2105, Tower One, Times Square
1 Matheson Street, Causeway Bay, Hong Kong
852 2123 9000

India

Bose Corporation India Private Limited
Salcon Aurum, 3rd Floor
Plot No. 4, Jasola District Centre
New Delhi - 110025, India
91 11 43080200

Italy

Bose SpA
Centro Leoni A - Via G. Spadolini
5 20122 Milano, Italy
39-02-36704500

Japan

Bose Kabushiki Kaisha
Sumitomo Fudosan Shibuya Garden Tower 5F
16-17, Nanpeidai-cho
Shibuya-Ku, Tokyo, 150-0036, Japan
TEL 81-3-5489-0955
www.bose.co.jp

The Netherlands

Bose BV
Nijverheidstraat 8 1135 GE
Edam, Nederland
0299-390139

United Kingdom

Bose Ltd
1 Ambley Green, Gillingham Business Park
KENT ME8 ONJ
Gillingham, England
0870-741-4500

Importer Information

European Union

Bose Products B.V., Gorslaan 60, 1441 RG
Purmerend, The Netherlands

China

Bose Electronics (Shanghai) Company
Limited, Part C, Plan 9, No. 353 North Riyang
Road, China (Shanghai) Pilot Free Trade Zone

Taiwan

Bose Taiwan Branch, 9F-A1, No. 10, Section 3,
Minsheng East Road, Taipei City 104, Taiwan
Tel: +886-2-2514 7676

Mexico

Bose de México, S. de R.L. de C.V., Paseo de
las Palmas 405-204, Lomas de Chapultepec,
11000 México, D.F.
Tel: +5255 (5202) 3545

UK Importer

Bose Limited, Bose House, Quayside Chatham
Maritime, Chatham, Kent, ME4 4QZ, United
Kingdom

See website for other countries

Additional Information

Refer to the owner's guide (online at www.Bose.com) for more information about your product (including accessories and replacement parts). To request a printed copy, use the phone numbers provided.

Limited Warranty

Your product is covered by a limited warranty. Visit www.pro.Bose.com for warranty details.

The warranty information provided with this product does not apply in Australia and New Zealand. See our website at www.bose.com/au/warranty or www.bose.com/nz/warranty for details of the Australian and New Zealand warranty.

Date of Manufacture

The eighth digit in the serial number indicates the year of manufacture; "6" is 2006 or 2016.