

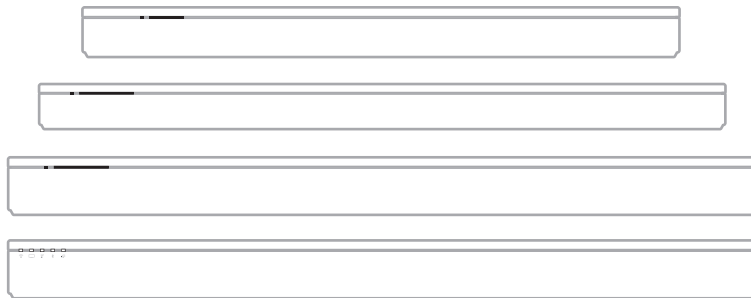

SURROUND SPEAKERS

START HERE



Choose your setup method

Your setup method depends on which soundbar you have.

Bose Soundbar 500, Bose Soundbar 700, or

Bose Smart Soundbar 300: See method 1.

SoundTouch 300 soundbar: See method 2.

METHOD 1

BOSE SOUNDBAR 500, BOSE SOUNDBAR 700, BOSE SMART SOUNDBAR 300



Set up using the Bose Music app

- a. In the Bose Music app, from the My Products screen, select your soundbar.
- b. Go to the Settings menu to add your surround speakers.

New to Bose Music app?

Download the app and follow the app instructions to set up your soundbar and surround speakers.

METHOD 2

SOUNDTOUCH 300 SOUNDBAR

①

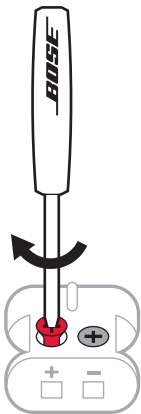

Connect your adapters

- Insert the color-coded speaker cable wires into their corresponding terminals.
- Turn the screws to the right (clockwise) to secure the wires into the terminals.
- Repeat steps a and b to connect your other adapter.

②

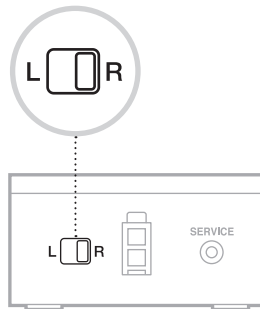

Identify switch settings on wireless receivers

- Confirm that the switch on one wireless receiver is set to **R** (right).
- Confirm that the switch on the other wireless receiver is set to **L** (left).

METHOD 2 (CONTINUED)

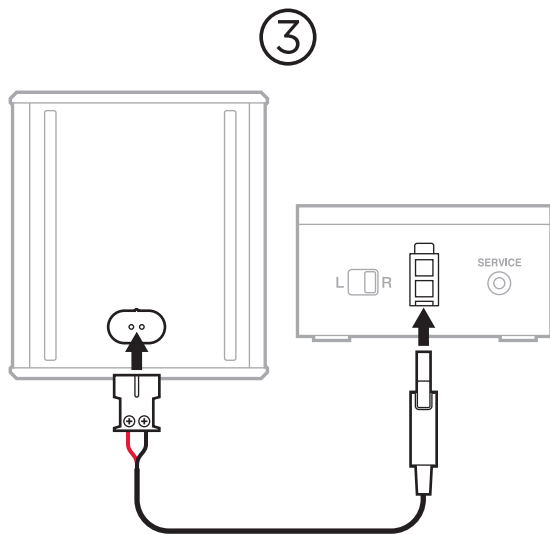

Connect your rear speakers

- Insert the adapter into the back of the speaker.
- Insert the two-pin connector into the wireless receiver.
- Repeat steps 1 and 2 to set up your other speaker.

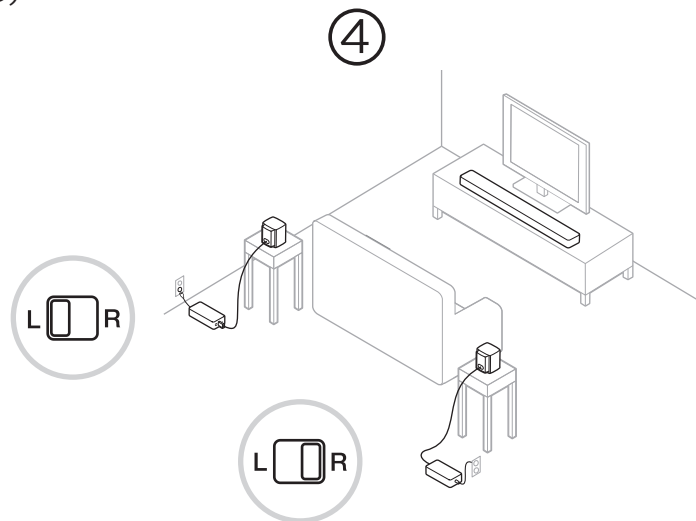

Place your rear speakers and wireless receivers

- Facing your TV, place the speaker and **R** wireless receiver on the **right** side of your room.
- Facing your TV, place the speaker and **L** wireless receiver on the **left** side of the room.
- Connect to power.



METHOD 2

(CONTINUED)

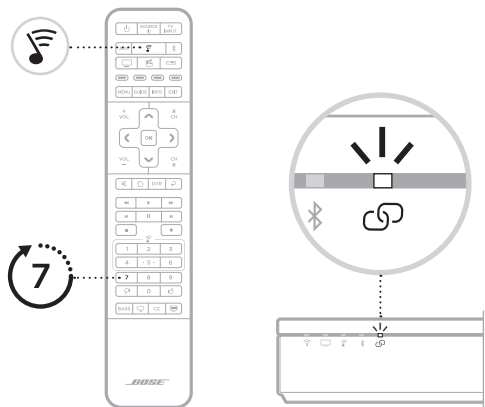
5



Connect the surround speakers to the soundbar

- On your SoundTouch 300 remote, press .
- Press and hold 7 until  on the soundbar blinks white.
Once the surround speaker connects, you hear a tone and  glows white.

NOTE: Connecting may take several minutes.

6

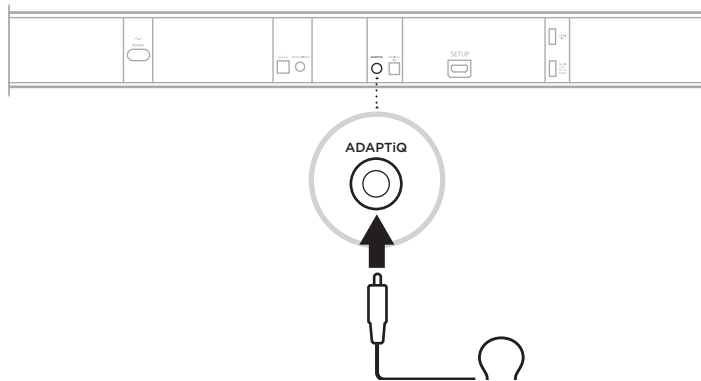



Set up ADAPTIQ audio calibration

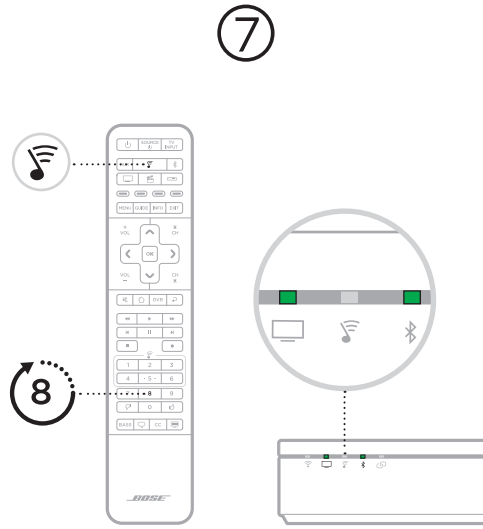

- Connect the ADAPTIQ headset (included with the soundbar) to the soundbar's ADAPTIQ connector.
- Put the headset on your head.

METHOD 2 (CONTINUED)



Run ADAPTiQ audio calibration

- On your SoundTouch 300 remote, press .
- Press and hold 8 until  and  on the soundbar glow green.

NOTE: To cycle through languages, press  and  on the navigation pad.



worldwide.Bose.com/Support/WSS



COMENZAR AQUÍ

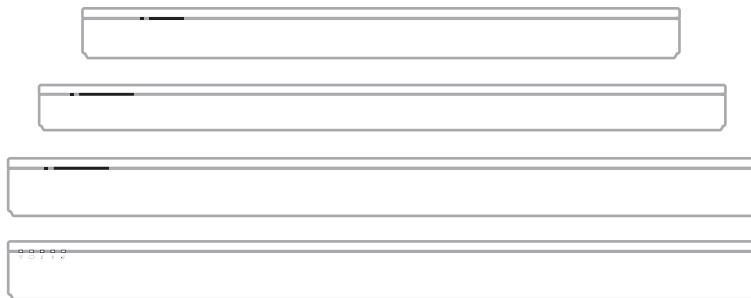

Elegir el método de configuración

El método de configuración depende de la barra de sonido que tenga.

Bose Soundbar 500, Bose Soundbar 700 o Bose Smart Soundbar 300:

Vea el método 1.

Barra de sonido SoundTouch 300: Vea el método 2.

MÉTODO 1

BOSE SOUNDBAR 500, BOSE SOUNDBAR 700, BOSE SMART SOUNDBAR 300



Configurar usando la aplicación Bose Music

- a. En la aplicación Bose Music, de la pantalla Mis productos, seleccione la barra de sonido.
- b. Vaya al menú de configuración y agregue los altavoces envolventes.

¿Es la primera vez que usa la aplicación Bose Music?

Descargue la aplicación y siga las instrucciones de la aplicación para configurar la barra de sonido y los altavoces envolventes.

MÉTODO 2

BARRA DE SONIDO SOUNDTOUCH 300

1

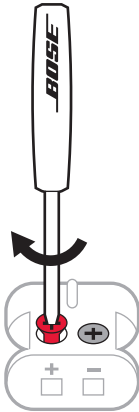

Conectar los adaptadores

- Inserte los cables del altavoz con código de color en las terminales correspondientes.
- Gire los tornillos hacia la derecha para asegurar los cables en las terminales.
- Repita los pasos a y b para conectar el otro adaptador.

2

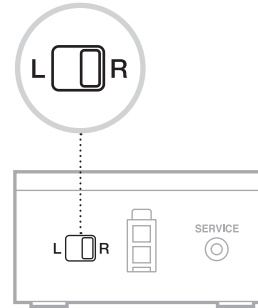

Identificar la configuración de los interruptores en los receptores inalámbricos

- Confirme que el interruptor en un receptor inalámbrico se encuentre en la posición **R** (derecha).
- Confirme que el interruptor en el otro receptor inalámbrico se encuentre en la posición **L** (izquierda).

MÉTODO 2 (CONTINUACIÓN)

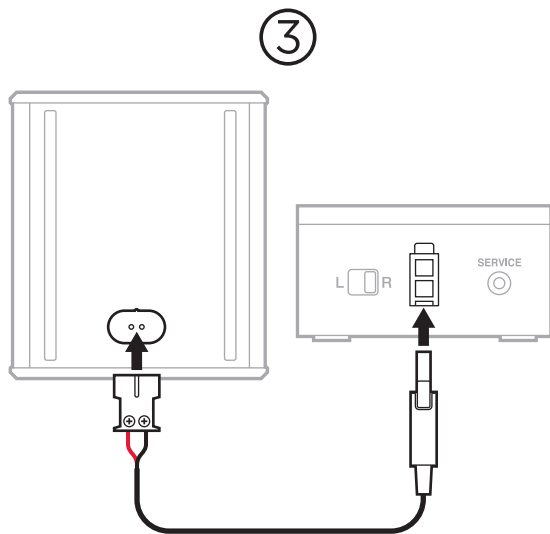

Conectar los altavoces traseros

- Inserte el adaptador en la parte posterior del altavoz.
- Enchufe el conector de dos pines en el receptor inalámbrico.
- Repita los pasos 1 y 2 para configurar el otro altavoz.

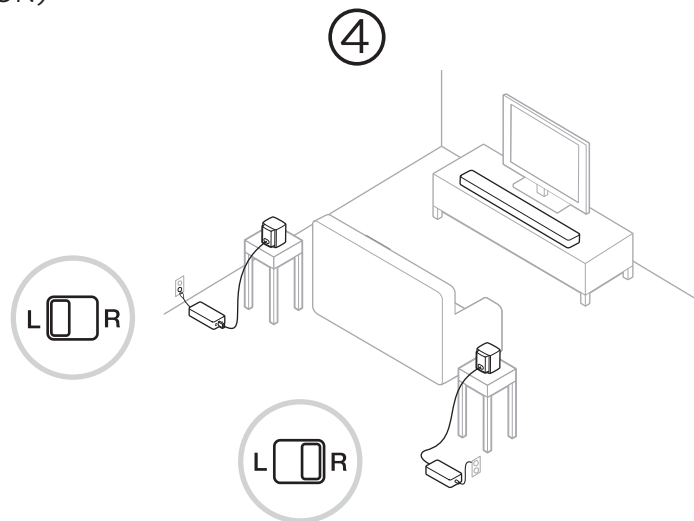

Ubicar los altavoces posteriores y receptores inalámbricos

- Mirando hacia la TV, coloque el altavoz y el receptor inalámbrico **R** en el lado **derecho** de la habitación.
- Mirando hacia la TV, coloque el altavoz y el receptor inalámbrico **L** en el lado **izquierdo** de la habitación.
- Conecte a la alimentación.

MÉTODO 2 (CONTINUACIÓN)

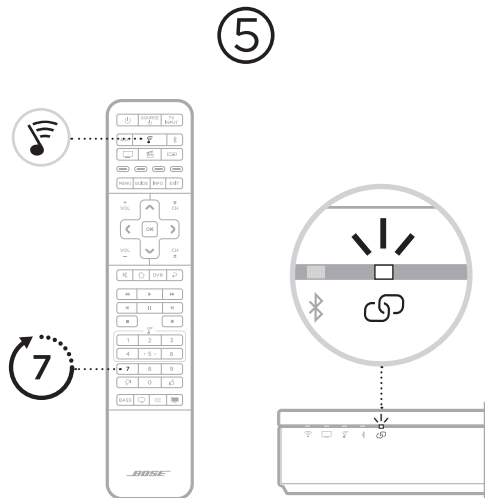

Conectar los altavoces envolventes a la barra de sonido

- En el control remoto de la barra de sonido SoundTouch 300, presione
- Mantenga presionado 7 hasta que en la barra de sonido parpadee de color blanco.

Una vez que se conectan los altavoces envolventes, se oye un tono y se ilumina de color blanco.

NOTA: La conexión puede tardar varios minutos.

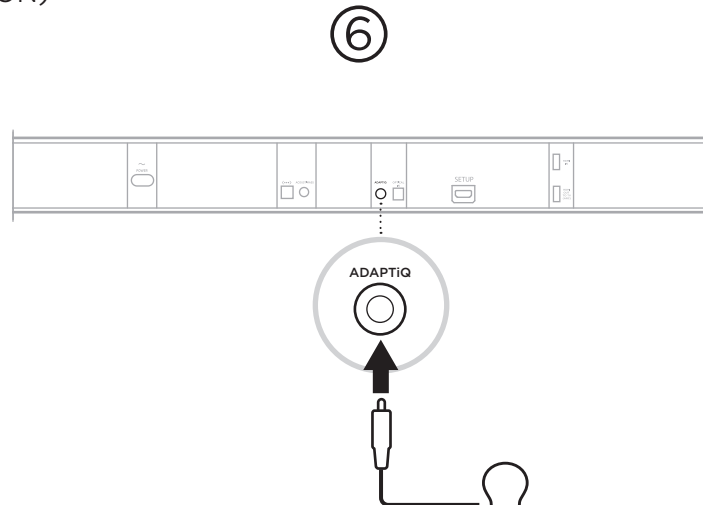

Configurar la calibración de audio ADAPTiQ

- Conecte los auriculares ADAPTiQ (incluidos con la barra de sonido) al conector ADAPTiQ de la barra de sonido.
- Colóquese los auriculares.

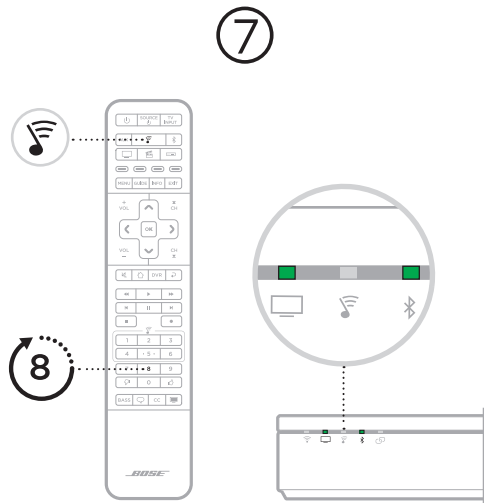

MÉTODO 2 (CONTINUACIÓN)





worldwide.Bose.com/Support/WSS



Ejecutar la calibración de audio ADAPTiQ

- En el control remoto de la barra de sonido SoundTouch 300, presione .
- Mantenga presionado 8 hasta que  y  en la barra de sonido se iluminen de color verde.

NOTA: Para cambiar entre los distintos idiomas, presione  y  en el panel de navegación.

COMMENCER PAR CE DOCUMENT

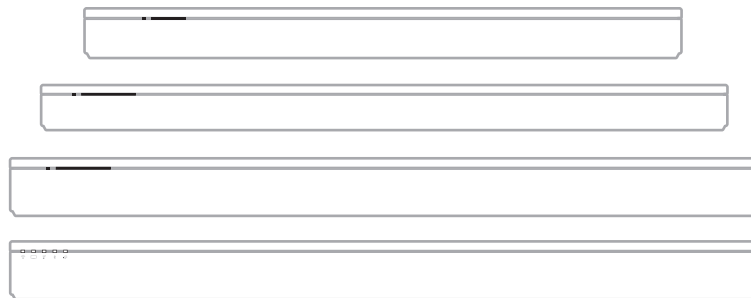

Sélection de la méthode de configuration

La méthode de configuration dépend de votre barre de son.

**Bose Soundbar 500, Bose Soundbar 700 ou
Bose Smart Soundbar 300** : voir la Méthode 1.

Barre de son SoundTouch 300 : voir la Méthode 2.

MÉTHODE 1

BOSE SOUNDBAR 500, BOSE SOUNDBAR 700, BOSE SMART SOUNDBAR 300



Configuration à l'aide de l'application Bose Music

- a. Dans l'application Bose Music, appuyez sur votre barre de son dans l'écran Mes produits.
- b. Accédez au menu Réglages pour ajouter vos enceintes surround.

Vous découvrez l'application Bose Music ?

Téléchargez l'application et suivez les instructions pour configurer votre barre de son et vos enceintes surround.

MÉTHODE 2

BARRE DE SON SOUNDTOUCH 300

①

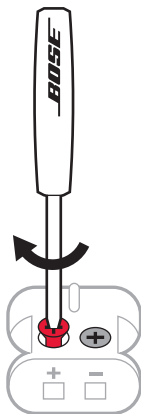

Connexion de vos adaptateurs

- Insérez les fils du câble d'enceinte de couleur dans les bornes correspondantes.
- Serrez les vis dans le sens des aiguilles d'une montre (vers la droite) pour fixer les fils aux bornes.
- Répétez les étapes a et b pour connecter l'autre adaptateur.

②

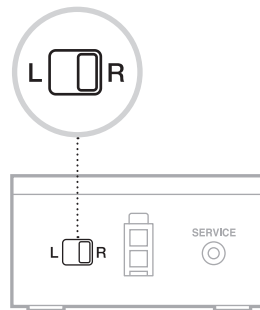

Identification des réglages d'interrupteur sur les récepteurs sans fil

- Vérifiez que l'interrupteur sur l'un des récepteurs sans fil est positionné sur **R** (droit).
- Vérifiez que l'interrupteur sur l'autre récepteur sans fil est positionné sur **L** (gauche).

MÉTHODE 2

(SUITE)

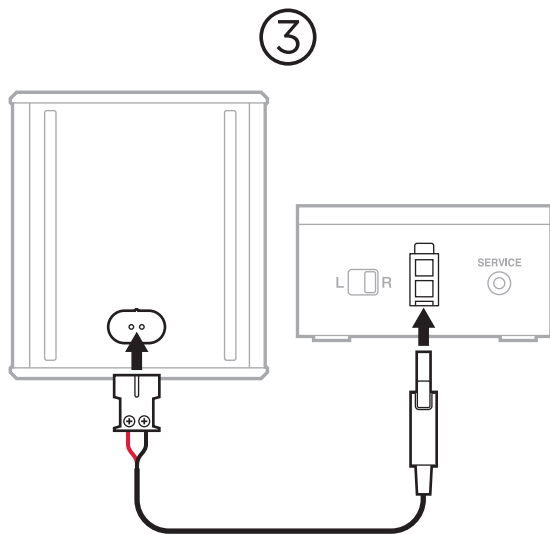

Connexion des enceintes arrière

- Insérez l'adaptateur à l'arrière de l'enceinte.
- Raccordez le connecteur à deux broches au récepteur sans fil.
- Répétez les étapes 1 et 2 pour connecter l'autre enceinte.

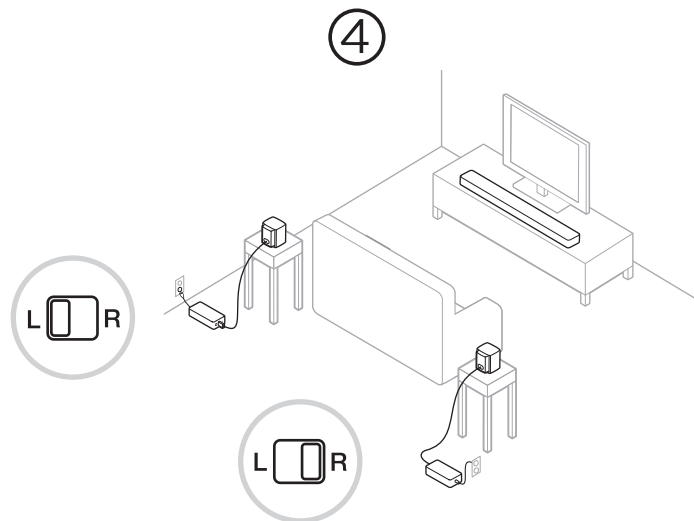

Installation des enceintes arrière et des récepteurs sans fil



- Installez l'enceinte et le récepteur sans fil **R** à **droite** de la pièce, face à votre téléviseur.
- Installez l'enceinte et le récepteur sans fil **L** à **gauche** de la pièce, face à votre téléviseur.
- Raccordez-le ensuite à la prise secteur.

MÉTHODE 2

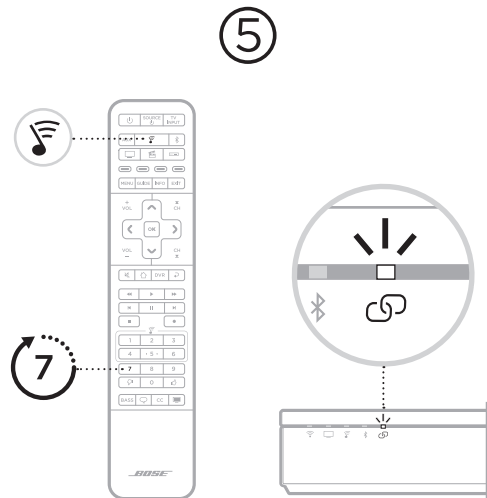
(SUITE)



Connexion des enceintes surround à la barre de son

- Sur la télécommande de votre barre de son SoundTouch 300, appuyez sur .
- Maintenez enfoncée la touche 7 jusqu'à ce que l'indication  clignote en blanc sur la barre de son.

Une fois les enceintes surround connectées, vous entendez une tonalité et  s'allume en blanc.

REMARQUE : la connexion peut prendre plusieurs minutes.

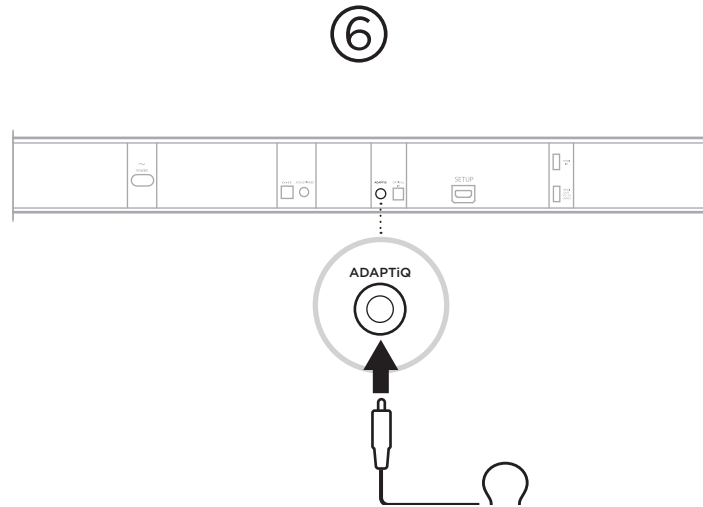

Configuration de l'étalonnage audio ADAPTiQ

- Raccordez le casque ADAPTiQ (fourni avec la barre de son) au connecteur ADAPTiQ de la barre de son.
- Placez le casque sur votre tête.

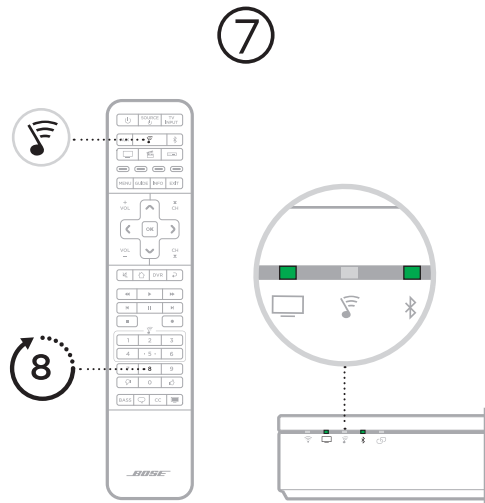

MÉTHODE 2 (SUITE)





worldwide.Bose.com/Support/WSS



Exécution de l'étalonnage audio ADAPTiQ

- Sur la télécommande de votre barre de son SoundTouch 300, appuyez sur .
- Maintenez enfoncée la touche 8 jusqu'à ce que les indications  et  clignotent en vert sur la barre de son.

REMARQUE : pour parcourir les langues, appuyez sur les touches  et  du pavé de navigation.

クイックスタートガイド

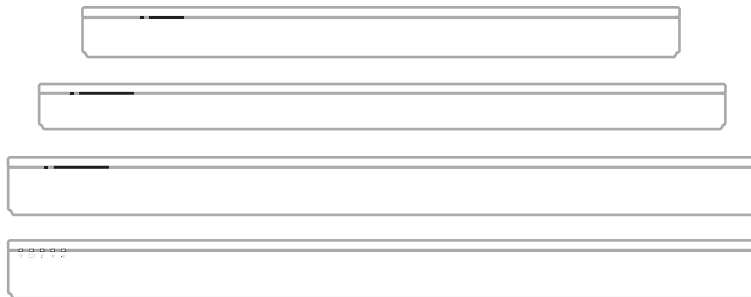

セットアップ方法を選択する

セットアップ方法はサウンドバーによって異なります。

**Bose Soundbar 500、Bose Soundbar 700、または
Bose Smart Soundbar 300:** 方法1をご覧ください。

SoundTouch 300 soundbar: 方法2をご覧ください。

方法1

BOSE SOUNDBAR 500、BOSE SOUNDBAR 700、またはBOSE SMART SOUNDBAR 300



Bose Music アプリを使用してをセットアップする

- a. Bose Music アプリの[製品]画面で、お使いのサウンドバーを選択します。
- b. [設定]メニューに移動して、Surround Speakersを追加します。

Bose Music アプリを初めて使用する場合

アプリをダウンロードし、アプリの指示に従ってサウンドバーとサラウンドスピーカーを設定します。

方法2

SOUNDTOUCH 300 SOUNDBAR

①

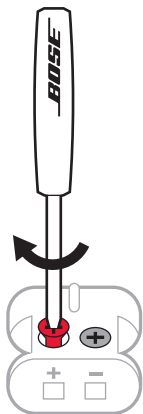

アダプターを取り付ける

- 極性が色分けされたスピーカーケーブルを対応する端子に差し込みます。
- ドライバーを右(時計回り)に回して、ケーブルを端子に固定します。
- 手順aとbを繰り返して、もう1個のアダプターも取り付けます。

②

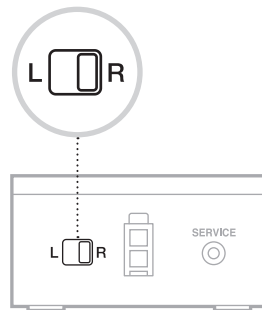

ワイヤレスレシーバーのスイッチを確認する

- 一方のワイヤレスレシーバーのスイッチが**R**(右)になっていることを確認します。
- もう一方のワイヤレスレシーバーのスイッチが**L**(左)になっていることを確認します。

方法2 (続き)

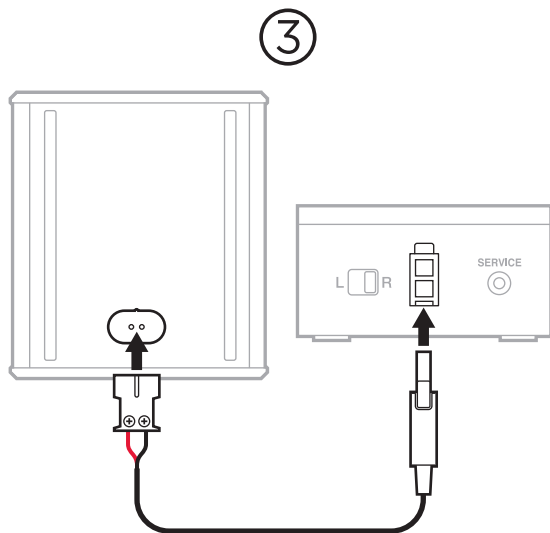

リアスピーカーを接続する

- スピーカー背面の端子にアダプターを差し込みます。
- 2芯コネクターをワイヤレスレシーバーに差し込みます。
- 手順1と2を繰り返して、もう一方のスピーカーも接続します。

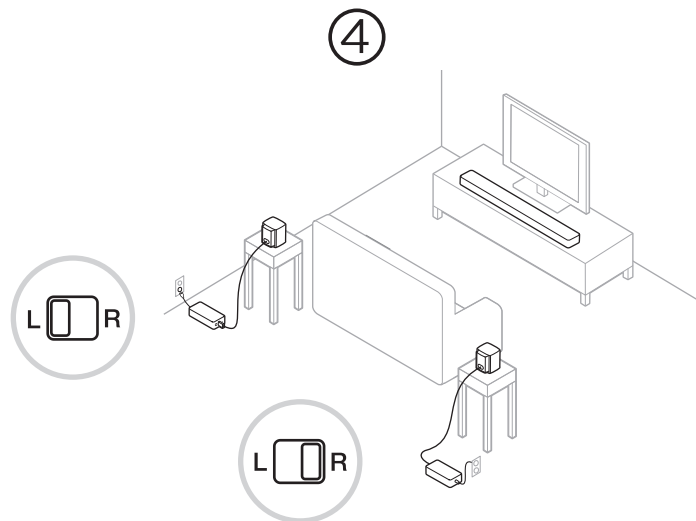

リアスピーカーとワイヤレスレシーバーを設置する



- テレビに向かって、部屋の**右側**にスピーカーと**R**に設定したワイヤレスレシーバーを設置します。
- テレビに向かって、部屋の**左側**にスピーカーと**L**に設定したワイヤレスレシーバーを設置します。
- 電源コンセントに接続します。

方法2 (続き)

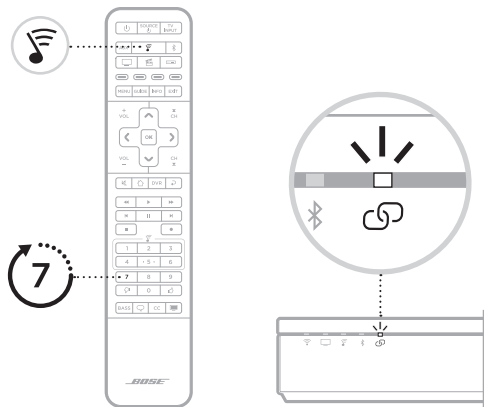
⑤



サラウンドスピーカーとサウンドバーを接続する

- SoundTouch 300のリモコンの  ボタンを押します。
- サウンドバーの  インジケータが白に点滅するまで7ボタンを長押しします。

サラウンドスピーカーが接続されると、ビープ音が聞こえ、 インジケータが白に点灯します。

注: 接続には数分かかる場合があります。

⑥

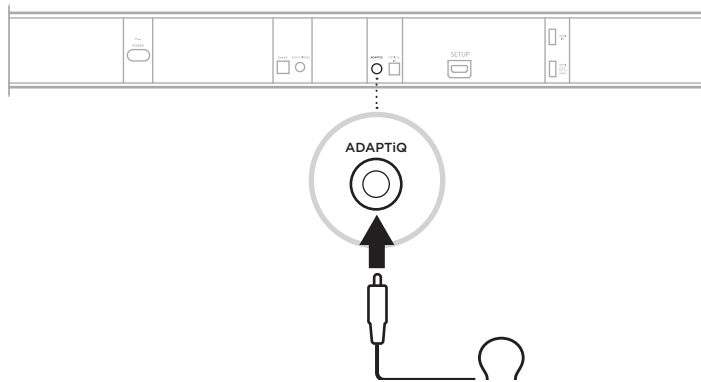

ADAPTiQ自動音場補正を準備する

- ADAPTiQ用ヘッドセット(サウンドバーに付属)をサウンドバーのADAPTiQ端子に接続します。
- ヘッドセットを頭に装着します。

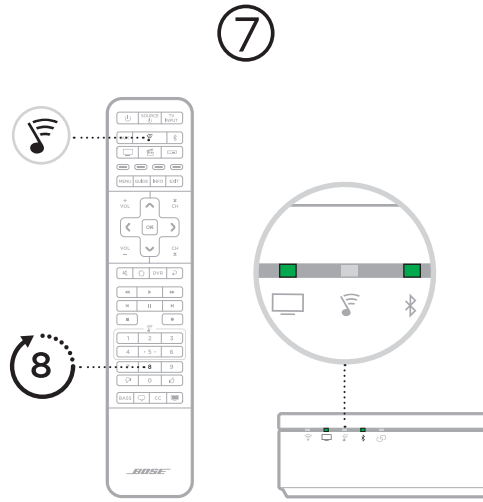

方法2 (続き)





worldwide.Bose.com/Support/WSS



ADAPTiQ 自動音場補正を実行する

- SoundTouch 300のリモコンの  ボタンを押します。
- サウンドバーの  および  インジケーターが緑に点灯するまで 8 ボタンを長押しします。

注: 言語を変更するには、ナビゲーションパッドの  ボタンや  ボタンを押します。



worldwide.Bose.com/Support/WSS



787797-0060