

BOSE

LIFESTYLE[®] 600
HOME ENTERTAINMENT SYSTEM



IMPORTANT SAFETY INSTRUCTIONS

Please read and keep all safety, security, and use instructions.

For more information about your Lifestyle® 600 home Entertainment System, visit:
global.bose.com/Support/LS600

C Bose Corporation hereby declares that this product is in compliance with the essential requirements and other relevant provisions of Directive 2014/53/EU and all other applicable EU directive requirements.
The complete declaration of conformity can be found at: www.bose.com/compliance

Important Safety Instructions

1. Read these instructions.
2. Keep these instructions.
3. Heed all warnings.
4. Follow all instructions.
5. Do not use this apparatus near water.
6. Clean only with a dry cloth.
7. Do not block any ventilation openings. Install in accordance with the manufacturer's instructions.
8. Do not install near any heat sources such as radiators, heat registers, stoves, or other apparatus (including amplifiers) that produce heat.
9. Protect the power cord from being walked on or pinched particularly at plugs, convenience receptacles, and the point where they exit from the apparatus.
10. Only use attachments/accessories specified by the manufacturer.
11. Unplug this apparatus during lightning storms or when unused for long periods of time.
12. Refer all servicing to qualified personnel. Servicing is required when the apparatus has been damaged in any way, such as power-supply cord or plug is damaged, liquid has been spilled or objects have fallen into the apparatus, the apparatus has been exposed to rain or moisture, does not operate normally, or has been dropped.



This symbol on the product means there is uninsulated, dangerous voltage within the product enclosure that may present a risk of electrical shock.



This symbol means there are important operating and maintenance instructions in this guide.



Contains small parts which may be a choking hazard. Not suitable for children under age 3.



This product contains magnetic material. Consult your physician on whether this might affect your implantable medical device.



This product contains a tempered glass surface. Use caution to avoid impact. In the event of breakage, use care in handling broken glass.

- To reduce the risk of fire or electrical shock, do NOT expose this product to rain, liquids or moisture.
- Do NOT expose this product to dripping or splashing, and do not place objects filled with liquids, such as vases, on or near the product.
- Keep the product away from fire and heat sources. Do NOT place naked flame sources, such as lighted candles, on or near the product.
- Do NOT make unauthorized alterations to this product.
- Do NOT use a power inverter with this product.
- Do NOT use in vehicles or boats.
- The speaker wire and interconnect cables included with this system are not approved for in-wall installation. Please check your local building codes for the correct type of wire and cable required for in-wall installation.
- Use this product only with the power supply provided.
- Where the mains plug or an appliance coupler is used as the disconnect device, the disconnect device shall remain readily operable.
-  仅适用于 2000m 以下地区安全使用
Use at altitude less than 2000 meters only.
- Due to ventilation requirements, Bose does not recommend placing the product in a confined space such as in a wall cavity or in an enclosed cabinet.
- Do not place or install the bracket or product near any heat sources, such as fireplaces, radiators, heat registers or other apparatus (including amplifiers) that produce heat.
- The product label is located on the bottom of the console.

NOTE: This equipment has been tested and found to comply with the limits for a Class B digital device, pursuant to Part 15 of the FCC Rules. These limits are designed to provide reasonable protection against harmful interference in a residential installation. This equipment generates, uses, and can radiate radio frequency energy and, if not installed and used in accordance with the instructions, may cause harmful interference to radio communications. However, there is no guarantee that interference will not occur in a particular installation. If this equipment does cause harmful interference to radio or television reception, which can be determined by turning the equipment off and on, the user is encouraged to try to correct the interference by one or more of the following measures:

- Reorient or relocate the receiving antenna.
- Increase the separation between the equipment and receiver.
- Connect the equipment into an outlet on a circuit different from that to which the receiver is connected.
- Consult the dealer or an experienced radio/TV technician for help.

Changes or modifications not expressly approved by Bose Corporation could void the user's authority to operate this equipment.

This device complies with part 15 of the FCC Rules and with ISED Canada license-exempt RSS standard(s). Operation is subject to the following two conditions: (1) This device may not cause harmful interference, and (2) this device must accept any interference received, including interference that may cause undesired operation.

This device for operation in the 5150 - 5250 MHz is only for indoor use to reduce the potential for harmful interference to co-channel mobile satellite systems.

This device complies with FCC and ISED Canada radiation exposure limits set forth for general population.

This equipment should be installed and operated with a minimum distance of 20 cm between radiator and your body.

This transmitter must not be co-located or operating in conjunction with any other antenna or transmitter.

Management Regulation for Low-power Radio-frequency Devices

Article XII

According to "Management Regulation for Low-power Radio-frequency Devices" without permission granted by the NCC, any company, enterprise, or user is not allowed to change frequency, enhance transmitting power or alter original characteristic as well as performance to an approved low power radio-frequency devices.

Article XIV

The low power radio-frequency devices shall not influence aircraft security and interfere legal communications; If found, the user shall cease operating immediately until no interference is achieved. The said legal communications means radio communications operated in compliance with the Telecommunications Act.

The low power radio-frequency devices must be susceptible with the interference from legal communications or ISM radio wave radiated devices.

The product, in accordance with the Ecodesign Requirements for Energy Related Products Directive 2009/125/EC, is in compliance with the following norm(s) or document(s): Regulation (EC) No. 1275/2008, as amended by Regulation (EU) No. 801/2013.

Required Power State Information	Power Modes	
	Standby	Networked Standby
Power consumption in specified power mode, at 230V/50Hz input	≤ 0.5 W	all network types ≤ 2.0 W
Time after which equipment is automatically switched into mode	< 2.5 hours	≤ 20 minutes
Power consumption in networked standby if all wired network ports are connected and all wireless network ports are activated, at 230V/50Hz input	N/A	≤ 2.0 W
Network port deactivation/activation procedures. Deactivating all networks will enable standby mode.	<p>Wi-Fi: Deactivate by pressing and holding the Source button on the console for 10 seconds. Repeat to activate Wi-Fi®.</p> <p>Bluetooth: Deactivate by clearing the pairing list via the on-screen menu, the remote screen, or the SoundTouch application. Activate by pairing with a Bluetooth® source.</p> <p>Ethernet: Deactivate by removing the Ethernet cable. Activate by inserting the Ethernet cable.</p>	

REGULATORY INFORMATION

External Power Supply Technical Information

The external power supply provided with the product, in accordance with the Ecodesign Requirements for Energy Related Products Directive 2009/125/EC, is in compliance with the following norms(s) or documents(s): Commission Regulation (EU) 2019/1782.

Manufacturer	Bose Products B.V.
Commercial registration number	36037901
Address	Gorslaan 60 1441 RG Purmerend The Netherlands
Model identifier	S088AP44001252
Input voltage	100V-240V
Input AC frequency	50Hz/60Hz
Output voltage	44V DC 10V DC
Output current	1.3A 3.3A
Output power	55W 33W
Average active efficiency	88.6%
Efficiency at low load (10%)	87.2%
No-load power consumption	0.11W

Manufacturer	Bose Products B.V.
Commercial registration number	36037901
Address	Gorslaan 60 1441 RG Purmerend The Netherlands
Model identifier	PSM88W-213
Input voltage	100V-240V
Input AC frequency	50Hz/60Hz
Output voltage	44V DC 10V DC
Output current	1.3A 3.3A
Output power	55W 33W
Average active efficiency	88.0%
Efficiency at low load (10%)	79.0%
No-load power consumption	0.17W

For Europe:

Frequency bands of operation 2400 to 2483.5 MHz, 5150 to 5350 MHz, and 5470 to 5725 MHz.

Maximum transmit power less than 20 dBm EIRP.

Maximum transmit power is below regulatory limits such that SAR testing is not necessary and exempt per applicable regulations.

This device is restricted to indoor use when operating in the 5150 to 5350 MHz frequency range in all EU Member States listed in the table.

									
BE	DK	IE	UK	FR	CY	SK	HU	AT	SE
BG	DE	PT	EL	HR	LV	LT	MT	PL	
CZ	EE	FI	ES	IT	RO	LU	NL	SI	

China Restriction of Hazardous Substances Table

Names and Contents of Toxic or Hazardous Substances or Elements						
Toxic or Hazardous Substances and Elements						
Part Name	Lead (Pb)	Mercury (Hg)	Cadmium (Cd)	Hexavalent (CR(VI))	Polybrominated Biphenyl (PBB)	Polybrominated diphenylether (PBDE)
PCBs	X	0	0	0	0	0
Metal Parts	X	0	0	0	0	0
Plastic Parts	0	0	0	0	0	0
Speakers	X	0	0	0	0	0
Cables	X	0	0	0	0	0
This table is prepared in accordance with the provisions of SJ/T 11364. O: Indicates that this toxic or hazardous substance contained in all of the homogeneous materials for this part is below the limit requirement of GB/T 26572. X: Indicates that this toxic or hazardous substance contained in at least one of the homogeneous materials used for this part is above the limit requirement of GB/T 26572.						

Taiwan Restriction of Hazardous Substances Table

Equipment name: Bose® Lifestyle® 600 home entertainment system , Type designation: 420128, 420132, 421088						
Restricted substances and its chemical symbols						
Unit	Lead (Pb)	Mercury (Hg)	Cadmium (Cd)	Hexavalent chromium (Cr+6)	Polybrominated biphenyls (PBB)	Polybrominated diphenyl ethers (PBDE)
PCBs	-	o	o	o	o	o
Metal Parts	-	o	o	o	o	o
Plastic Parts	o	o	o	o	o	o
Speakers	-	o	o	o	o	o
Cables	-	o	o	o	o	o
Note 1: "o" indicates that the percentage content of the restricted substance does not exceed the percentage of reference value of presence. Note 2: The "-" indicates that the restricted substance corresponds to the exemption.						



This symbol means the product must not be discarded as household waste, and should be delivered to an appropriate collection facility for recycling. Proper disposal and recycling helps protect natural resources, human health and the environment. For more information on disposal and recycling of this product, contact your local municipality, disposal service, or the shop where you bought this product.

Please complete and retain for your records

The serial and model numbers are located on the side of the carton.

Serial number: _____

Model number: _____

Please keep your receipt with your owner's guide. Now is a good time to register your Bose product.

You can easily do this by going to global.Bose.com/register

Date of Manufacture: The eighth digit in the serial number indicates the year of manufacture; "0" is 2010 or 2020.

China Importer: Bose Electronics (Shanghai) Company Limited, Part C, Plant 9, No. 353 North Riyang Road, China (Shanghai) Pilot Free Trade Zone

EU Importer: Bose Products B.V., Gorslaan 60, 1441 RG Purmerend, The Netherlands

Taiwan Importer: Bose Taiwan Branch, 9F-A1, No.10, Section 3, Minsheng East Road, Taipei City 104, Taiwan.

Phone number: +886-2-2514 7676

Mexico Importer: Bose de México, S. de R.L. de C.V., Paseo de las Palmas 405-204, Lomas de Chapultepec, 11000 México, D.F.

Phone number: +5255 (5202) 3545

LEGAL INFORMATION

Security Information



This product is capable of receiving automatic security updates from Bose. To receive automatic security updates, you must complete the product setup process in the SoundTouch® App and connect the product to the Internet. **If you do not complete the setup process, you will be responsible for installing security updates that Bose makes available.**

License Disclosures

You can view the license disclosures that apply to the software packages included with your home theater system through the SoundTouch app or by using your product's IP address.

SoundTouch app

1. From within the app, select ≡ > **Settings > About > Legal**.
2. Select the applicable license type.

IP address

1. Obtain your product's IP address using one of the following methods:
 - **SoundTouch app:** From within the app, select ≡ > **Settings > About**. Select your home theater system to view the IP address.
 - **Wireless router:** Refer to your router owner's guide for more information.
 - **System:** On the remote, press the **SETUP** button. In the UNIFY menu, select **System Info > Network** to view the IP address.
2. On a device connected to your wireless network, open a browser window.
3. Go to **<IP address>/licenses.pdf** to view the applicable license disclosures.

Apple and the Apple logo are trademarks of Apple Inc., registered in the U.S. and other countries. App Store is a service mark of Apple Inc.

Android, Google Play, and the Google Play logo are trademarks of Google LLC.

Amazon, Amazon Music, Kindle, Fire and all related logos are trademarks of Amazon, Inc. or its affiliates.

The *Bluetooth*® word mark and logos are registered trademarks owned by Bluetooth SIG, Inc. and any use of such marks by Bose Corporation is under license.

 **DOLBY AUDIO**™ Manufactured under license from Dolby Laboratories. Dolby and the double-D symbol are registered trademarks of Dolby Laboratories.



For DTS patents, see <http://patents.dts.com>. Manufactured under license from DTS, Inc. DTS, the Symbol, DTS and the Symbol together, Digital Surround, and the Digital Surround logo are registered trademarks or trademarks of DTS, Inc. in the United States and/or other countries.
© DTS, Inc. All Rights Reserved.



The terms HDMI and HDMI High-Definition Multimedia Interface, and the HDMI logo are trademarks or registered trademarks of HDMI Licensing Administrator, Inc.

iHeartRadio is a registered trademark of iHeartMedia, Inc.

Deezer is a registered trademark of Blogmusik SAS.

This product is protected by certain intellectual property rights of Microsoft. Use or distribution of such technology outside of this product is prohibited without a license from Microsoft.

The N-Mark is a trademark or registered trademark of NFC Forum, Inc. in the United States and in other countries.

Pandora, the Pandora logo, and the Pandora trade dress are trademarks or registered trademarks of Pandora Media, Inc. used with permission.

SiriusXM Internet Radio subscription sold separately and available only to those at least 18 years of age residing in the U.S. and Puerto Rico. To subscribe to SiriusXM Internet Radio in the U.S., U.S. customers should visit www.sirius.com or call 1-888-539-7474.

SiriusXM and all related marks and logos are trademarks of Sirius XM Radio Inc. and its subsidiaries. All rights reserved.

SoundTouch and the wireless note design are registered trademarks of Bose Corporation in the U.S. and other countries.

This product incorporates Spotify software which is subject to third-party licenses found here:

www.spotify.com/connect/third-party-licenses

Spotify is a registered trademark of Spotify AB.

Designed with UEI Technology™. Under License from Universal Electronics, Inc. © UEI 2000-2016

Wi-Fi is a registered trademark of Wi-Fi Alliance®.

Windows is a registered trademark of Microsoft Corporation in the United States and other countries.

Bose Corporation Headquarters: 1-877-230-5639

©2020 Bose Corporation. No part of this work may be reproduced, modified, distributed or otherwise used without prior written permission.

Getting Started

Unpacking	10
Layer 1	11
Layer 2	11
Layer 3	12
Layer 4	12
Placement guidelines	13
Sample system placement	14

Setting Up the System

UNIFY® system overview.....	15
UNIFY® setup	16

Using the Remote Control

Remote control overview	17
Using the SOURCE button	18
Function buttons.....	18
Adjusting volume	18
Using the MORE button.....	18
The AV OUTPUT menu.....	18
The AV SETTINGS menu.....	19
Remote glow button	19

SoundTouch® App Setup

Download and install the SoundTouch® app	20
SoundTouch® Owner's Center.....	20

Existing SoundTouch® Users

Add the system to an existing account.....	21
Connect the system to a new network	21

Preset Personalization

Set a preset	22
Play a preset	22
Set a preset using your remote control	22
Select a preset using your remote control	22

CONTENTS

Bluetooth® Technology

Choosing your pairing method	23
Connect your mobile device	23
Pair a device with NFC	24
Control your connected mobile device from the remote control	24
Connect using the <i>Bluetooth</i> feature on your mobile device	24
Connect using your remote control	25
Disconnect a mobile device	25
Pair another mobile device	25
Reconnect a device	25
Clear the system's <i>Bluetooth</i> pairing list	25

Advanced Features

Disabling Wi-Fi® capability	26
Re-enabling Wi-Fi capability	26
Updating the system software	26

Getting System Information

System status indicators.....	27
Console LED indicator	27
Acoustimass® wireless bass module LED indicator	28
Wireless receiver LED indicator	28

Care and Maintenance

Cleaning.....	29
Customer service	29
Limited warranty.....	29
Technical information.....	29
SERVICE connector	29

Troubleshooting

Common solutions.....	30
Setting up your IR emitter.....	33
Checking for sound	34

Appendix A: Installation Reference

Front console panel..... 35

 Front Headphones/AUX input..... 35

 Front HDMI™ input..... 35

Back console panel..... 35

Connecting an AC-2 adapter 36

Installing the front speakers..... 37

 What you need:..... 37

Connecting the front speakers to the console 38

Installing the rear speakers 39

 What you need:..... 39

Identifying switch settings on wireless receivers..... 40

Connecting the rear speakers..... 40

Connecting the rear speakers to power 41

Mounting your speakers 41

Appendix B: System Maintenance

Replacing the remote control's batteries 42

Appendix C: Alternate Wired Setup

Unable to pair the Acoustimass® wireless bass module with the console..... 43

Unable to pair the wireless receivers with the console (rear speakers)..... 43

Unpacking

The parts of your new Lifestyle® Home Entertainment System are packaged in four layers, some of which contain multiple boxes of components. Each box is marked by icons to indicate its contents.

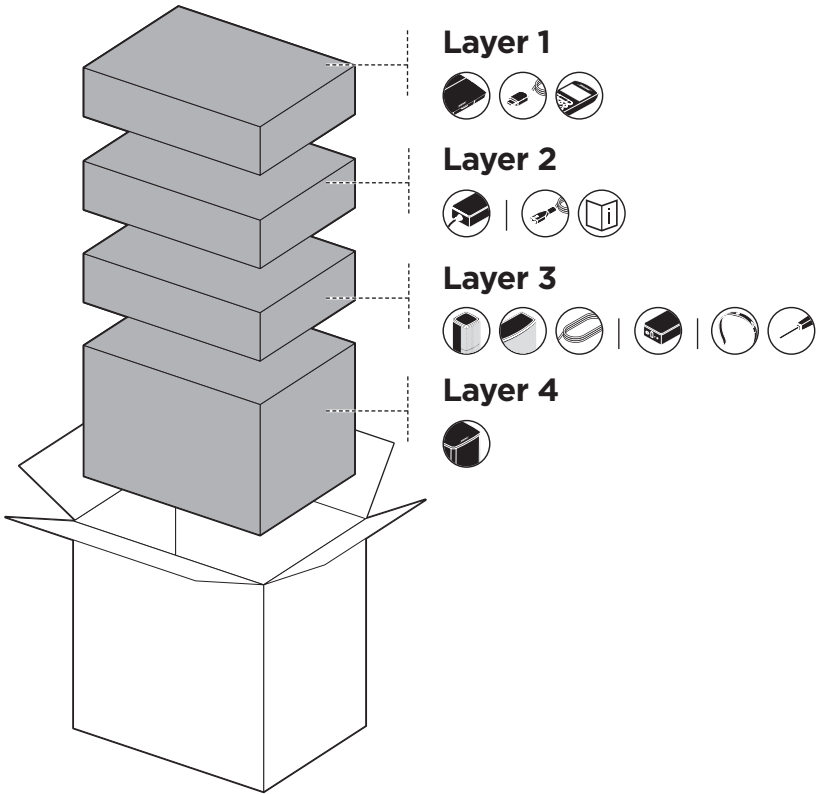

Note: If part of the system is damaged or the glass on your console or Acoustimass® wireless bass module is broken, do not use it. Contact your authorized Bose® dealer or Bose customer service.

Layer 1

From box    :

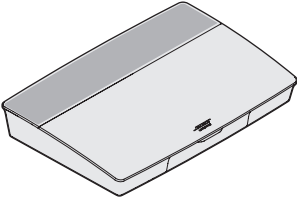

Console (1)

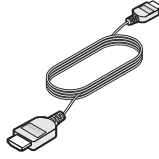

HDMI™ cable (1)

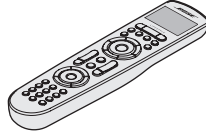

Universal remote control (1)

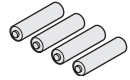

AA batteries (4)

Layer 2

From box  :

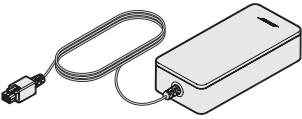

Console power supply (1)

From box   :

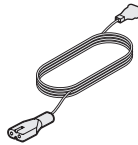

Power cords (4)*



Owner's guide (1)

*May ship with multiple power cords. Use the power cord for your region.

GETTING STARTED

Layer 3

From box    :

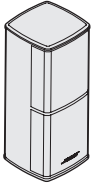

Jewel Cube® speakers (4)

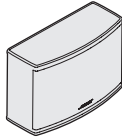

Jewel Cube® center speaker (1)



Front speaker cable (1)

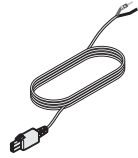

Rear speaker cables (2)



AC-2 adapters (5)

From box   :

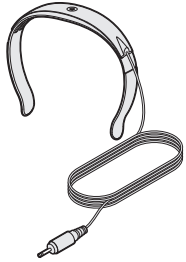

ADAPTiQ® headset (1)

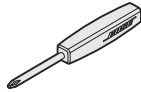

Screwdriver (1)



IR emitter (1)

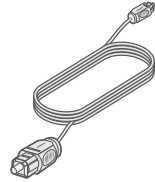

Optical cable (1)

Layer 4

From box  :

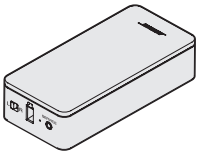

Wireless receivers (2)

From box  :

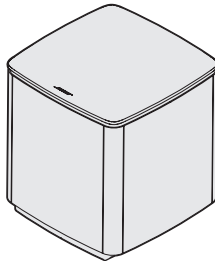

Acoustimass® wireless bass module (1)

Placement guidelines

To avoid interference, keep other wireless equipment 1 – 3 ft. (0.3 – 0.9 m) away from the system. Place your system outside of and away from metal objects and direct heat sources.

Component	Recommended placement
Console	<ul style="list-style-type: none"> Place the console near your components. The recommended placement is near your TV. Do NOT place the TV or any other components on top of your console. Place your console in a well-ventilated area. Make sure there is an AC (mains) outlet nearby. <p>Note: Until your system is completely installed, keep the control console positioned for easy access to its rear connector panel.</p>
Acoustimass® wireless bass module	<ul style="list-style-type: none"> Stand the bass module on its rubber feet along the same wall as your TV, or along any other wall in the front third of the room. Choose a stable and level surface. Vibration can cause the bass module to move, particularly on smooth surfaces like marble, glass or highly polished wood. Keep the front side of the bass module at least 3 in. (8 cm) from any other surface. Blocking the port on the bottom of this side can affect acoustic performance. Make sure there is an AC (mains) outlet nearby.
Front speakers	<ul style="list-style-type: none"> Place one speaker to the left and one speaker to the right of the TV. If placing the speakers in an enclosed bookcase shelf, position them at the front edge of the shelf.
Center speaker	<ul style="list-style-type: none"> Place the center speaker on a stable and level surface directly above or below your TV.
Rear speakers/ wireless receivers	<ul style="list-style-type: none"> Place the rear speakers toward the back of the room behind the viewers at ear height (when seated) or higher, if possible. Confirm that the switch on one wireless receiver is set to L (left). Confirm that the switch on the other wireless receiver is set to R (right). Facing the TV, place the speaker and L wireless receiver on the left side of the room. Facing the TV, place the speaker and R wireless receiver on the right side of the room. Make sure there is an AC (mains) outlet near each wireless receiver.

Sample system placement

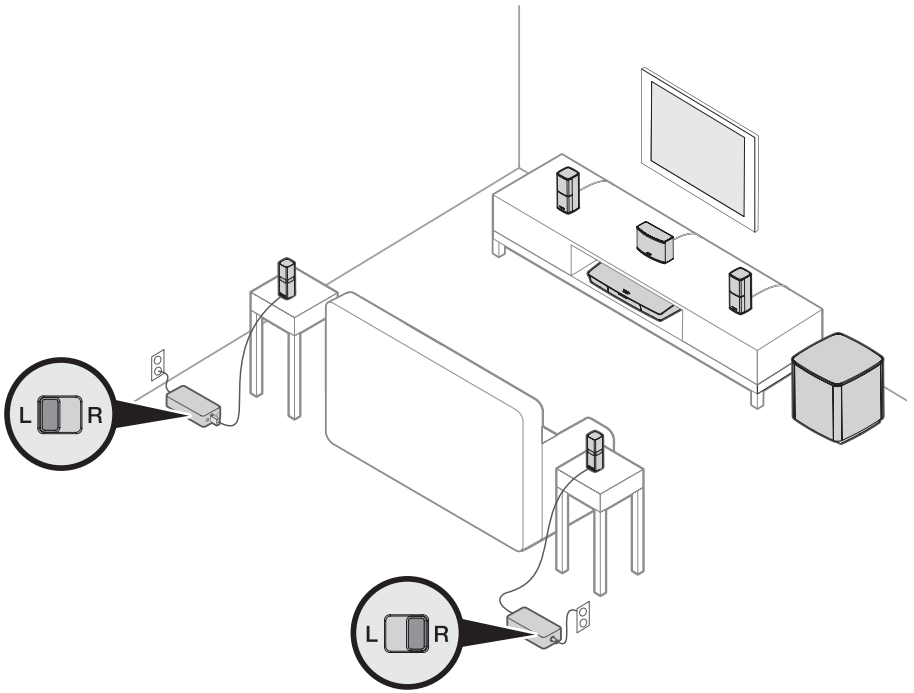

UNIFY® system overview

The UNIFY intelligent integration system guides you through the initial process of setting up and configuring your system. It helps you choose the correct cables and inputs and programs the Bose® remote control to operate your connected devices.

Note: Before you begin, make sure you have one hour set aside for system setup.

Menu item	What you can do
Bluetooth Setup	Manage your <i>Bluetooth</i> devices.
Device Management	Add another device or accessory to your system.
Network Setup	Connect your system to your home network.
Software Update	Perform a system software update.
Power Macro	Customize the Power button  on your remote control to power on/off your system, TV and another HDMI source simultaneously.
Auto-off	Disable your system from powering off automatically when there is no signal after 20 minutes.
Headphone Connector	Set the default usage of your front headphones/AUX input (see page 35).
CEC Settings	Adjust the CEC functionality of your console. <ul style="list-style-type: none"> • Default On: CEC is enabled • Alternate On: Prevents CEC-enabled devices from changing the currently selected source • Off: CEC is turned off
ADAPTiQ®	Start the ADAPTiQ audio calibration process. Once completed, this menu option disables or enables ADAPTiQ.
TV Remote Setup	Program your remote to control your TV.
Advanced TV Audio Setup	Learn more about HDMI (ARC) and set up your preferred usage.
Speaker Management	Revisit your system's speaker setup or add an additional Acoustimass® wireless bass module.
Language Select	Change the language of the on-screen display.
Tutorial	A series of optional procedures to help guide you through the system's key features, such as SoundTouch®.
Exit	Close the UNIFY menu.

UNIFY® setup

The following steps are part of the initial UNIFY setup process:

Step	Objective
Pair the remote control	Connect the system's remote control to the console.
Choose language	Select your language from the on-screen list.
Connect to network	Select and connect to your home Wi-Fi network or Ethernet.
Software update	Update system software to provide the most current functionality.
Wired speakers	Connect the front speakers to the console.
Wireless speakers	Connect the rear speakers and Acoustimass® wireless bass module to the console.
TV remote	Set up the system's remote control to control your TV.
Adding devices	Connect your additional sources.
ADAPTiQ® setup	Customizes the sound of the system to the acoustics of your listening area.
Tutorial	A series of optional procedures to help guide you through the rest of your system's features, such as SoundTouch®.

After completing the initial setup, you can access the UNIFY menu at any time to change your system setup and configuration. Press the **SETUP** button on the remote control to start UNIFY setup.

Remote control overview

The Bose® advanced RF (radio frequency) remote control works from anywhere in your room without requiring you to aim the remote control at the console.

The remote control's display is an essential part of your Lifestyle® experience. It guides you through your sources and system settings.

Note: The Bose remote control does not control functions specific to devices that are connected to the front HDMI™ input.

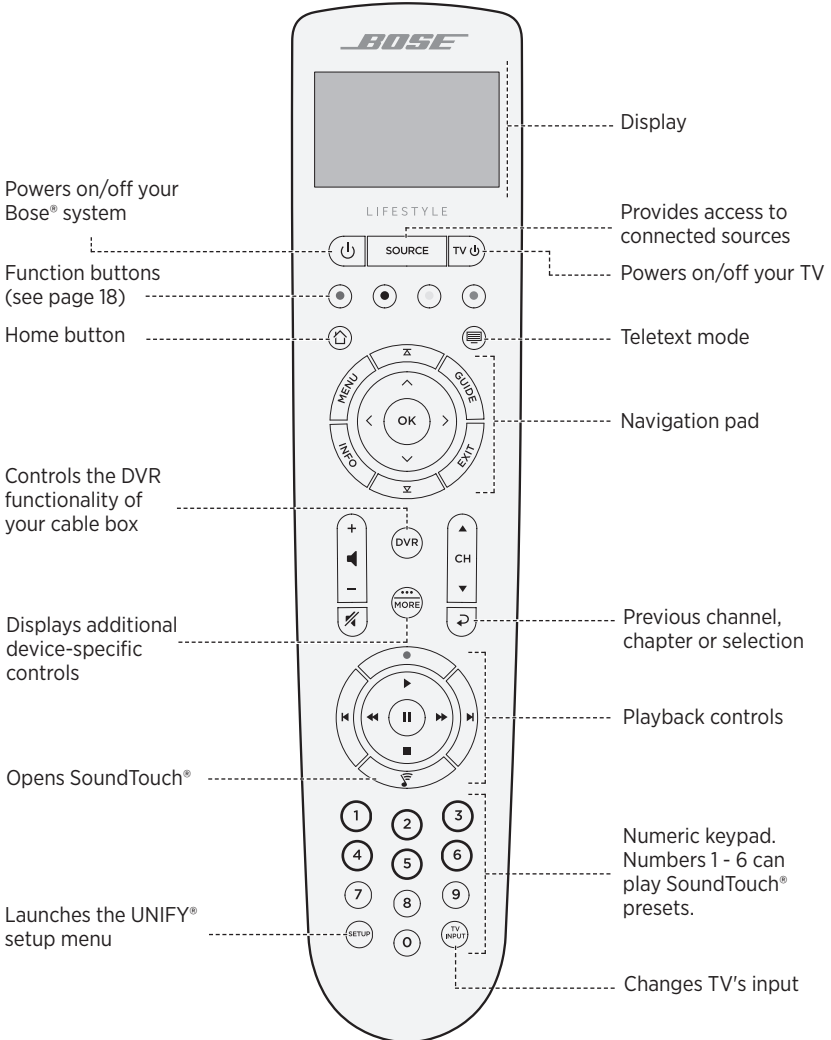

Using the SOURCE button

The **SOURCE** button is used to switch between connected sources. Access sources using the navigation pad on your remote control.

Once a source is highlighted, press **OK** to select it.

Function buttons

The red, green, yellow and blue buttons on the remote control correspond with the color-coded function buttons on your cable/satellite box or teletext functions.

- **Cable/satellite box functions:** refer to your cable/satellite box owner's guide.
- **Teletext functions:** correspond with color-coded page numbers, headings or shortcuts on a teletext display.

Adjusting volume



To see your volume level, refer to your remote control's display.

- Press **+** to increase the volume.
- Press **-** to decrease the volume.
- Press  to mute or unmute the audio.

Note: If you still hear audio from your TV's speakers after setting up your system, disable the speakers through your TV's settings menu.

Using the MORE button

The MORE button  lets you access additional selections through the remote control's display that pertain to your currently-selected source, as well as other system control functionality.

1. Press .
2. Press  or  to select a function on your remote control's display.
3. Press **OK**.



The AV OUTPUT menu

The AV OUTPUT menu displays the current video resolution, frame rate, audio format and number of audio channels for the currently selected source.

1. Press  on your remote control.
2. Select **AV OUTPUT**.
3. Press the **OK** button.
4. Press **EXIT**.

The AV SETTINGS menu

The AV SETTINGS menu lets you adjust certain system settings. The number of items that appear depends on the currently-selected source. To access the menu:

1. Press  on your remote control.
2. Select **AV SETTINGS**.
3. Press the **OK** button to display the AV SETTINGS menu for the current source.
4. Press  or  to highlight the option you want to change.
5. Press **OK** to select the setting.
6. Press **EXIT** when done.

AV setting	Objective
SYSTEM AV	Adjust your system's treble, bass, center and surround audio levels.
SOURCE AV	<ul style="list-style-type: none"> • AUDIO: <ul style="list-style-type: none"> - Dialogue mode enhances speech clarity. - Movie mode provides balanced playback for most listening situations. - Night mode adjusts dialog and volume during loud scenes. - Music mode provides optimized playback for music. • AV SYNC: Adjust the timing between your device's audio and video. • AUDIO TRACK: Select between multiple language tracks.
NOTIFICATION	Enables a flash on your remote control's display to notify you when an input is required.
RESTORE DEFAULTS	Restores your audio to default values.
REMOTE INFO	Displays your remote control's serial number and software version.

Remote glow button

Press  on the rear of the remote control to illuminate the button backlighting for dark viewing situations.

SOUNDTOUCH® APP SETUP

The SoundTouch® app lets you set up and control SoundTouch® from your smartphone, tablet or computer. Using the app, your smart device acts as a remote for your console.

From the app, you can manage your SoundTouch® settings, add music services, explore local and global Internet radio stations, set and change presets and stream music. New features are added periodically.

Note: If you have already set up SoundTouch® for another system, see page 21.

Download and install the SoundTouch® app

On your smartphone or tablet, download the Bose® SoundTouch® app.



SoundTouch® app

- **Apple users:** download from the App Store
- **Android™ users:** download on the Google Play™ store
- **Amazon Kindle Fire users:** download from the Amazon Appstore for Android



Follow the instructions in the app to complete setup, including adding the system to your Wi-Fi network, creating a SoundTouch® account, adding a music library and using music services.

Once you set up the system on your home Wi-Fi network, you can control it from any smartphone or tablet on the same network.

Tip: You must use the same SoundTouch® account for all devices connected to your console.

Note: If you have already added your system to your Wi-Fi network, select **SYSTEM ALREADY ON NETWORK** when prompted in the app.

SoundTouch® Owner's Center

 global.bose.com/Support/LS600

This website provides access to the owner support center, which includes: owner's manuals, articles, tips, tutorials, a video library, and the owner community where you can post questions and answers.

Add the system to an existing account

If you have already set up SoundTouch® on another system, you do not need to download the SoundTouch® app again.

From within the app, select  > **Settings** > **Add or Reconnect Speaker**.

The app guides you through setup.

Connect the system to a new network

If your network information changes, add your system to your new network. You can do this by putting your system into setup mode.

1. From within the app, select  > **Settings** > **System Speaker** and select your system.
2. Select **CONNECT SPEAKER**.

The app guides you through setup.

PRESET PERSONALIZATION

You can personalize six presets to your favorite streaming music services, stations, playlists, artists, albums or songs from your music library. You can access your music, at any time, with a simple touch of a button using the SoundTouch® app.

Before using presets, note the following:

- You can set presets from the app and the remote control.
- If the preset source is your music library, make sure the computer storing your music library is on and connected to the same network as the SoundTouch® console.
- You cannot set presets to a *Bluetooth* stream or cabled mobile device.

Set a preset

1. Stream music using the app.
2. While the music is playing, press and hold a preset in the app.

Play a preset

Once you personalize your presets, press a preset in the app to play it.

Set a preset using your remote control

1. Press the  on your remote control to access the SoundTouch source.
2. Press and hold a number (from 1 – 6) on the numeric keypad to assign a new preset. A tone notifies you that a new preset has been set.

Select a preset using your remote control

1. Assign your favorite stations as presets within the app.
2. Press the **SoundTouch®** button  on your remote control to switch to the SoundTouch source.
3. Select a preset by pressing a number (from 1 – 6) on the numeric keypad.

Bluetooth wireless technology lets you stream music from *Bluetooth* smartphones, tablets, computers or other devices to your console. Before you can stream music from a mobile device, you must connect the mobile device with your console.

Choosing your pairing method

You can pair your mobile device with the console using *Bluetooth* wireless technology or Near Field Communication (NFC).

What is NFC?

NFC is a technology that enables devices to establish wireless communication with each other by simply tapping the devices together. Refer to your device owner's guide to see if your model supports NFC.

If your device does not support NFC or if you are unsure:	Follow the instructions for "Connect your mobile device."
If your device supports NFC:	Follow the instructions for "Pair a device with NFC" on page 24.

Note: If your device supports *Bluetooth* pairing via NFC, you can use either pairing method.

Connect your mobile device

1. Press the **SOURCE** button on your remote control and select **Bluetooth** on your remote control's display.
2. Follow the on-screen instructions to place your console in pairing mode.
3. From within the SoundTouch® app, select your system from the device tray.
4. Select **Bluetooth** .
5. Select **CONNECT**.
6. Select your Lifestyle® system from the mobile device list.

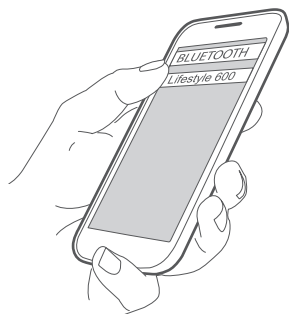

Tip: Look for the name you entered for your system in the app. If you didn't name your system, the default name appears.

Once connected, your system's name appears connected in the device list.

Pair a device with NFC

1. With your system powered on, unlock your device and turn on the *Bluetooth* and *NFC* features. Refer to your device owner's guide to learn more about these features.
2. Gently tap the NFC touchpoint on your mobile device to the area above the Bose® logo on the top of your Lifestyle® console.

Your mobile device may prompt you to accept pairing.

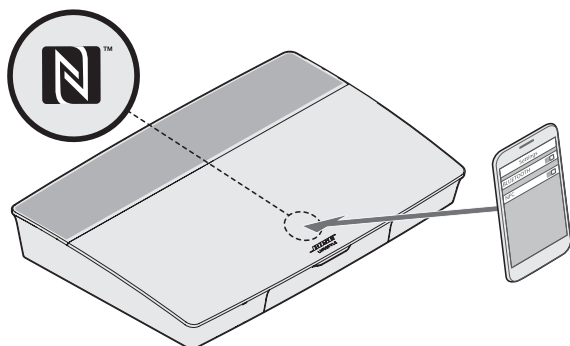

Control your connected mobile device from the remote control

Once paired, you can use the remote control to access your connected mobile devices. Select *Bluetooth* from the **SOURCE** menu. To connect a device, see page 23.

You can use the remote to control the following subset of *Bluetooth* features on your system:

- Pair and connect devices.
- View available artist information.
- Control playback (play, pause, stop, skip to the next track, etc.).
- Clear the pairing list.

Connect using the *Bluetooth* feature on your mobile device

1. On your mobile device, turn on the *Bluetooth* feature.
Tip: The *Bluetooth* menu is usually found in the Settings menu.
2. Select your system from the mobile device list.

Connect using your remote control

You can stream audio from a device to your console.

1. Turn on the *Bluetooth* feature on your device.
2. On your remote control, choose the *Bluetooth* source through the **SOURCE** menu.
The console connects to the last device that streamed music to the system.
3. On the device, play music.

Disconnect a mobile device

Turn off the *Bluetooth* feature on your mobile device.

Pair another mobile device

To pair another device, press the **SETUP** button and select **Bluetooth Setup** (see page 15).

Reconnect a device

- When powered on, the console tries to reconnect with the most recently connected device.
Note: The device must be within range and powered on.
- If your device supports NFC, gently tap the NFC touchpoint on your mobile device to the area above the Bose® logo on the top of your console.

Clear the system's *Bluetooth* pairing list

From within the app, select **☰ > Settings > Speaker Settings > Select Speaker > Bluetooth® > Clear Bluetooth® Pairing List > Clear.**

The pairing list clears.

You can also clear your system's pairing list on the console.

1. Press the **SETUP** button.
2. Select **Bluetooth Setup.**
3. Select **Clear Bluetooth pairing list.**

Disabling Wi-Fi capability

1. Press and hold your console's **SOURCE** button for 10 seconds.
2. Release the **SOURCE** button.

Re-enabling Wi-Fi capability

Your system's Wi-Fi automatically re-enables when powering on your system.

Updating the system software

If your system is connected to your home network, it checks for software updates every time the system is used. If an update is available, it begins downloading automatically.

If an update was fully downloaded, on-screen text prompts you when powering down the console that it is ready to be installed. Your system shuts down automatically after installation.

System status indicators

The front of the console has an LED indicator that shows system status. The LED glows according to system state.

Console LED indicator

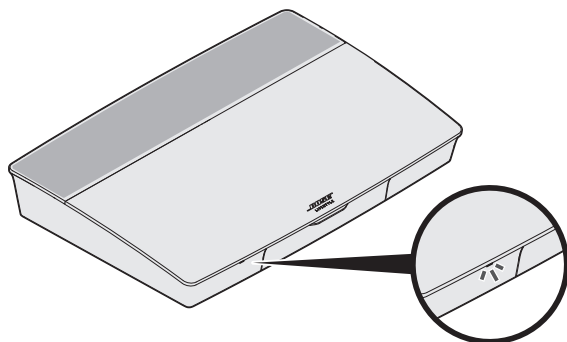

Indicator activity	System state
Off	System is off
Blinking white	System is powering on
Solid white	System powered on
Blinking amber	Downloading system software update
Solid amber	No network connection
Solid red	Firmware error - contact Bose® customer service

Acoustimass® wireless bass module LED indicator

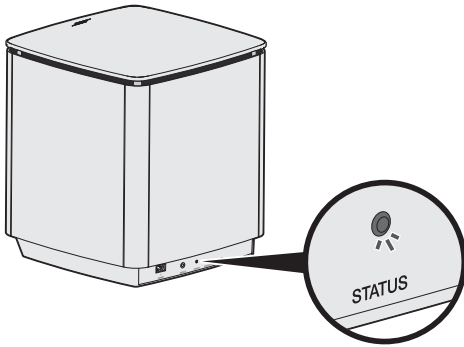

Indicator activity	System state
Blinking amber	Ready to pair
Solid white	Connected to the console
Solid amber (dim)	Disconnected from the console
Blinking white	Downloading system software update
Blinking red	Firmware error - contact Bose® customer service

Wireless receiver LED indicator

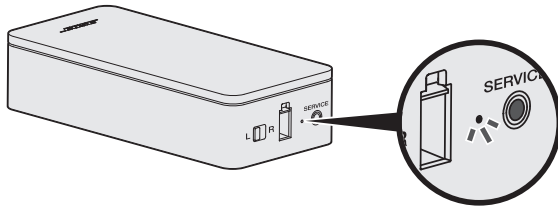

Indicator activity	System state
Blinking amber	Ready to pair
Solid white	Connected to the console
Solid amber (dim)	Disconnected from the console
Blinking white	Downloading system software update
Blinking red	Firmware error - contact Bose® customer service

Cleaning



Do not allow liquids to spill onto the system or into any openings.

- Clean the exterior of the system with the provided cleaning cloth or another soft, dry cloth.
- Do not use any sprays near the system.
- Do not use any solvents, chemicals or cleaning solutions containing alcohol, ammonia or abrasives.
- Do not allow objects to drop into any openings.

Customer service

For additional help using the system:

- Visit global.Bose.com/Support/LS600
- Contact Bose® customer service.

Limited warranty

The system is covered by a limited warranty. Visit our website at global.Bose.com/warranty for details of the limited warranty.

To register your product, visit global.Bose.com/register for instructions. Failure to register will not affect your limited warranty rights.

Technical information

U.S.A./Canada/International:

- **Console:** 10VDC 3.3A, 44VDC 1.25A
- **Wireless receivers:** 100–240V 50/60 Hz, 30W
- **Acoustimass® wireless bass module:** 100–240V \sim 50/60 Hz, 180W

SERVICE connector

The SERVICE connector is for service use only. Do not insert any cables into this connector.

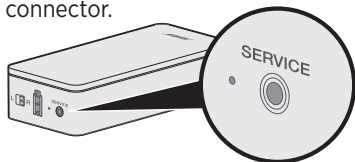

TROUBLESHOOTING

If you experience problems with your home entertainment system:

- Make sure that all system components are connected to an AC (mains) outlet.
- Secure all cables.
- Check the state of system status indicators (see page 27).
- Move the system away from possible interference (wireless routers, cordless phones, televisions, microwaves, etc.).
- Verify the system is within the recommended range of wireless router or mobile device for proper operation.

If you could not resolve your issue, see the table below to identify symptoms and solutions to common problems. If you are unable to resolve your issue, contact Bose® customer service.

Common solutions

The following table lists symptoms and possible solutions to common problems.

Symptom	Solution
The system is not responding to initial operation of remote control	<ul style="list-style-type: none">• Power on the control console manually from the front of the unit by pressing the Power button .• Press any button on your remote control. The system status indicator on the control console should blink with each press.• Make sure the remote control's batteries are installed correctly and do not need replacement (see page 42).• Unplug the power cord for the console, wait 30 seconds and plug it firmly into a live AC (mains) outlet.
The remote does not control a device added during initial setup	Connect your IR emitter (see page 33).
The TV is still playing sound	Disable your TV speakers through your TV's settings menu.
Poor video connection from a source	Press the SETUP button on the control console and select your device's setup options. Follow the on-screen instructions to change a video connection.
System does not respond	<ul style="list-style-type: none">• Select a connected device from the SOURCE menu.• Unplug the power cord for the console, wait 30 seconds and plug it firmly into a live AC (mains) outlet.
Problems related to HDMI (ARC)	<p>Make sure that the system's HDMI™ cable is inserted into a connector on your TV labeled ARC or Audio Return Channel.</p> <p>If your TV does not have an HDMI ARC connector, press the SETUP button on the remote control and select Advanced TV Audio Settings from the UNIFY® menu (see page 15).</p>

Symptom	Solution
Problems related to CEC	<p>If the console is connected to your TV's HDMI ARC connector, make sure that Consumer Electronics Control (CEC) is enabled in your TV system menu. Your TV may refer to CEC by a different name.</p> <p>For more information, refer to your TV owner's guide or press the SETUP button on the remote control and select CEC Settings from the UNIFY® menu (see page 15).</p>
A connected device switches on its own	<p>Press the SETUP button on the remote control and select Alternate On from the CEC Settings UNIFY® menu item (see page 15).</p>
No sound from the system	<ul style="list-style-type: none"> • Increase the volume. • Press the Mute button  on the remote control to make sure the system is not muted. • Make sure you have selected the correct source. • Cycle through and test different sources. • Make sure that the HDMI™ cable is inserted into a connector on your TV labeled ARC or Audio Return Channel. If your TV does not have an HDMI ARC connector, use a secondary audio cable in addition to the HDMI cable. • If using a secondary audio cable, insert the cable into a connector on your TV labeled Output or OUT. • Unplug the power cord for the console, wait 30 seconds and plug it firmly into a live AC (mains) outlet.
Cannot complete network setup	<ul style="list-style-type: none"> • Select the correct network name and enter password (case sensitive). • Connect to the network using an Ethernet cable. • Restart your modem and router.
Cannot complete SoundTouch® setup	<ul style="list-style-type: none"> • Connect the mobile device and the system to the same Wi-Fi network. • If you have already added your system to your Wi-Fi network, select SYSTEM ALREADY ON NETWORK when prompted in the app. • Enable Wi-Fi on the mobile device you are using for setup. • Test your internet connection. • Restart your mobile device. • Restart your modem and router. • Uninstall the app, reinstall the app, reset the system and restart setup.
Acoustimass® wireless bass module status LED is a solid amber (dim)	<ul style="list-style-type: none"> • Follow the on-screen troubleshooting prompts. • Press the SETUP button on the control console or your remote and select Speaker Management to rerun setup (see page 15). • Connect the bass module using a 3.5 mm stereo cable (see page 43). • Unplug the power cord for the Acoustimass, wait 30 seconds and plug it firmly into a live AC (mains) outlet.
Bass is too heavy or low	<ul style="list-style-type: none"> • Adjust the bass setting of the system (see page 19). • Run ADAPTIQ® audio calibration (see page 16). • Move the bass module away from nearby walls and corners.

TROUBLESHOOTING

Symptom	Solution
The wireless receiver status LEDs are solid amber (dim)	<ul style="list-style-type: none"> • Follow the on-screen troubleshooting prompts. • Press the SETUP button on the control console or your remote and rerun the UNIFY® setup (see page 16). • Unplug the power cords for the receivers, wait 30 seconds and plug them firmly into a live AC (mains) outlet. • Make a wired connection to your rear speakers (see page 43).
Sound is distorted	<ul style="list-style-type: none"> • Cycle through and test different sources. • Reduce the volume output level from any devices connected to the control console. • Make sure the audio input cable from your source device is connected and not damaged. • If you have not previously run ADAPTiQ®, select ADAPTiQ® from the UNIFY® menu (see page 15). • Unplug the power cord for the console, wait 30 seconds and plug it firmly into a live AC (mains) outlet.
No sound from a connected device	<ul style="list-style-type: none"> • Power on the device. • Cycle through and test different sources. • Refer to the device owner's manual.
No TV picture, but audio is heard	Make sure the TV video input selection is correct for the video source.
A connected device is not responding consistently to remote commands	<ul style="list-style-type: none"> • Try setting up the device again. Press the SETUP button on the control console. Select the device options and follow the on-screen instructions to set up the device again. • Replace your remote's batteries (see page 42). • Set up your IR emitter (see page 33).
Intermittent audio dropouts heard on coaxial digital audio devices	<ul style="list-style-type: none"> • Confirm that the audio cable is properly connected to the console and the coaxial digital audio device. • Cycle through and test different sources. • Try setting up the device again. Press the SETUP button on the control console. Select the coaxial digital audio device options and follow the on-screen instructions to set up the device again. • Unplug the power cord for the console, wait 30 seconds and plug it firmly into a live AC (mains) outlet.
Not all remote buttons have the desired function while controlling a TV or source device.	Press the SETUP button on your remote control and select TV Remote Setup > Advanced setup .
Connecting to a new network or different network	<ul style="list-style-type: none"> • Press the SETUP button and select Network Setup. • If your network information has changed or to connect your system to another network, refer to the SoundTouch® in-app help. • If having problems connecting wirelessly, connect to the network using an Ethernet cable.

Symptom	Solution
Cannot play <i>Bluetooth</i> audio	<p>On your system:</p> <ul style="list-style-type: none"> • Pair a mobile device using the <i>Bluetooth</i> SOURCE screen. • Clear the system's pairing list using the remote control: <ul style="list-style-type: none"> - In the <i>Bluetooth</i> source, press the MORE button  on your remote. - Select Clear Pairing List. • Try pairing a different mobile device. <p>On your mobile device:</p> <ul style="list-style-type: none"> • Disable and re-enable the <i>Bluetooth</i> feature. • Remove the system from the <i>Bluetooth</i> menu. Pair again. • Refer to your device's documentation. • See "No sound from the system" on page 31.

Setting up your IR emitter

If you are having issues with the responsiveness of your remote and your connected devices, Bose® recommends using the provided IR emitter.

Note: Use the IR emitter only if you are having remote control issues from a third party device.

1. Remove the IR emitter from box  .
2. Insert the emitter into the **IR** connector on the back of the console.

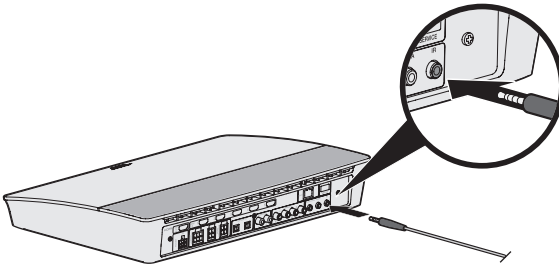

3. Remove three adhesive pads from the plastic sheet included with the emitter and place them on the flat bottoms of the three emitter beads.

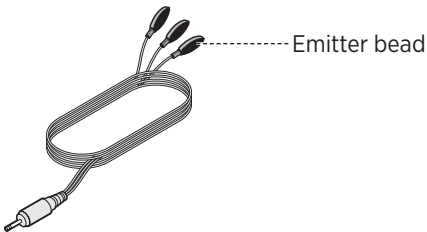

4. Remove the plastic backing from the adhesive pads.

TROUBLESHOOTING

5. Place the three IR beads into the cabinet housing your device or directly in front of the device itself.
6. Test the responsiveness of your remote. If problems still exist, reposition the IR beads and test again.

Checking for sound

1. Power on your TV.
2. If you are using a cable/satellite box or other secondary source:
 - Power on this source.
 - If your secondary source is connected to your TV, select the appropriate TV input.
3. Power on your console.

You should hear sound coming from the bass module.

Note: If you do not hear sound from the bass module, see “Troubleshooting” on page 31.

Front console panel

The front of the console has the following inputs:

- Headphones
- HDMI™ input

These inputs appear in the **SOURCE** menu as AUX IN and HDMI (Front) when a device is connected. They can be used to connect digital cameras, video cameras, media players and your preferred mobile device.

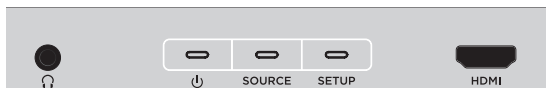

Front Headphones/AUX input

You can use this 3.5 mm input with your headphones, or as an audio option with your favorite mobile device. The headphone setting is the default option.

To use this input as an AUX IN, press the **SETUP** button on your remote control and select **Headphone Connector** from the on-screen display. Select **AUX IN** from the **SOURCE** menu when a device is connected.

Front HDMI™ input

You can use this input for devices that have an HDMI output.

Note: The Bose remote control does not control functions specific to devices that are connected to the front HDMI™ input.

Back console panel

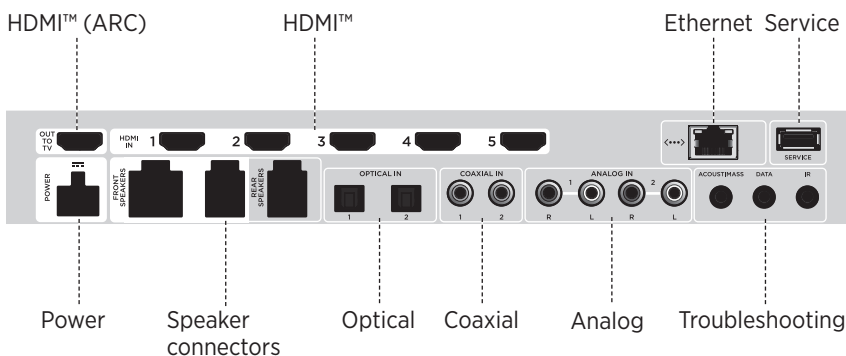

Connecting an AC-2 adapter

1. Using the screwdriver, turn the screws to the left (counterclockwise) to loosen the wire terminals.

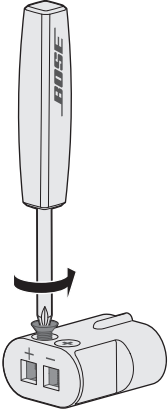

2. **For front speakers:** Insert the bare ends of the four-pin cable into the adapter by placing the red wire marked **L+**, **C+** or **R+** into the red terminal (**+**) and the plain wire into the plain silver terminal (**-**).

For rear speakers: Insert the bare ends of the two-pin cable into the adapter by placing the red wire marked **+** into the red terminal (**+**) and the plain wire into the plain silver terminal (**-**).

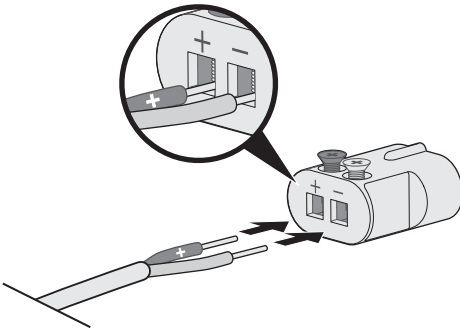

Note: Be sure to only insert the bare ends of each exposed wire to avoid clamping the wire's insulation.

3. Using the screwdriver, turn the screws right (clockwise) to secure the wires into the terminals.
4. Repeat steps 1 - 4 to connect the other adapter.

Installing the front speakers

UNIFY® setup guides you through the initial installation of your front speakers during the “Wired speakers” step (see page 16).

If you are moving your system but have already completed setup, refer to the following instructions in order to reassemble the rear portion of your home entertainment system.

CAUTION: Do not connect your speakers while your console is connected to an AC (mains) adapter.

What you need:

From box  :

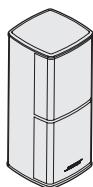

Jewel Cube® speakers (2)

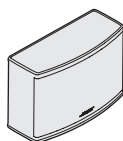

Jewel Cube® center speaker (1)



AC-2 adapters (3)

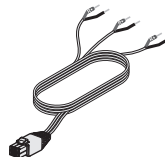

Front speaker cable (1)

From box  :

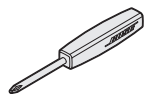

Screwdriver (1)

Connecting the front speakers to the console

1. Connect the AC-2 adapters to the bare ends of the speaker wire. See “Connecting an AC-2 adapter” on page 36.
2. Insert the adapter connected to the wire marked **L+** into the speaker on the left of your TV.
3. Insert the adapter connected to the wire marked **R+** into the speaker on the right of your TV.
4. Insert the adapter connected to the wire marked **C+** into the center speaker.
5. Connect the remaining end of the six-pin cable into the six-pin **FRONT SPEAKERS** connector on the back of your console.

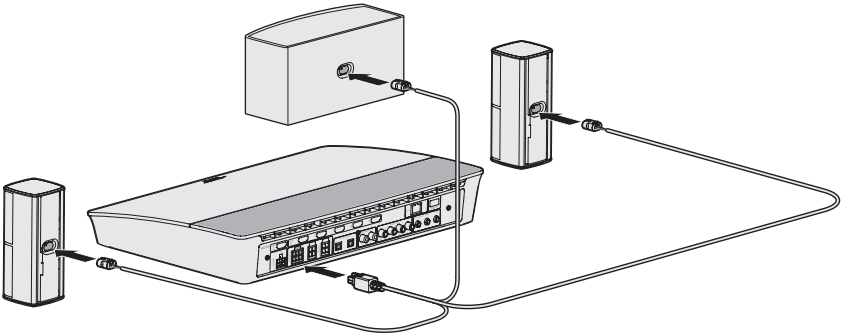

Note: The four-pin FRONT SPEAKERS connector on the back of your console is not used.

Installing the rear speakers

UNIFY® setup guides you through the initial installation of your rear speakers during the “Wireless speakers” step (see page 16).

If you are moving your system but have already completed setup, refer to the following instructions in order to reassemble the rear portion of your home entertainment system.

Note: If you are unable to pair your rear speakers to the console, you can also connect them directly to the system using a custom speaker cable (not provided).

For further instruction, see page 43.

What you need:

From box   :

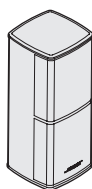

Jewel Cube® speakers (2)



Rear speaker cables (2)



AC-2 adapters (2)

From box  :

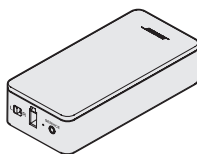

Wireless receivers (2)

From box   :

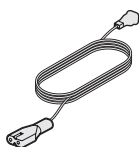

Power cords (2)

From box   :

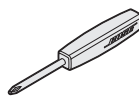

Screwdriver (1)

Identifying switch settings on wireless receivers

Your rear speakers connect to wireless receivers to communicate with the console. The receivers come preset to a left and right channel out of the box. You can use the switch on the front of the receiver to adjust the channel settings.

1. Confirm that the switch on one wireless receiver is set to **L** (left).
2. Confirm that the switch on the other wireless receiver is set to **R** (right).

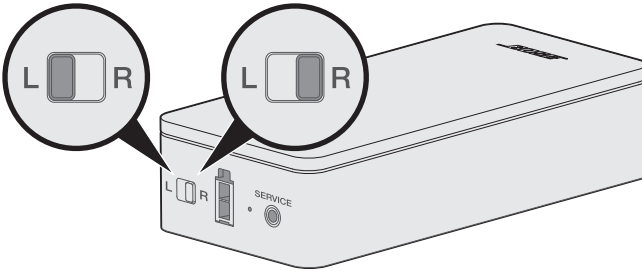

Note: Make sure that one wireless receiver is always set to **L** (left) and the other is set to **R** (right).

Connecting the rear speakers

1. Connect the AC-2 adapters to the bare ends of the speaker wire. See “Connecting an AC-2 adapter” on page 36.
2. Insert the adapter into the back of your speaker.
3. Insert the other end of the two-pin cable into your wireless receiver.

You hear or feel a click.

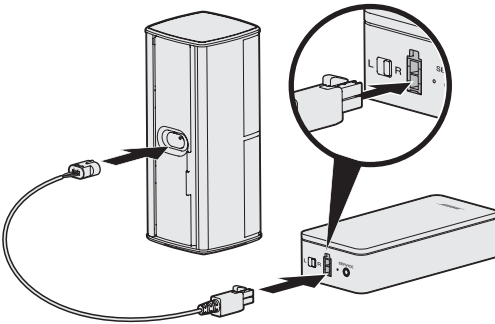

4. Repeat steps 1 - 3 to connect your other speaker.

Connecting the rear speakers to power

1. Connect one end of the power cord into your wireless receiver.
2. Plug the other end of the power cord into an AC (mains) outlet.

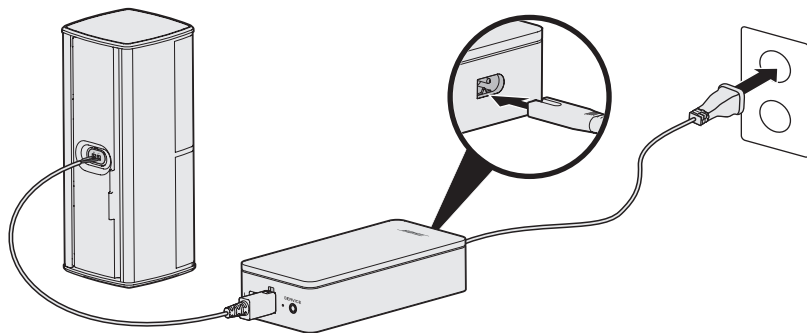

3. Repeat steps 1 and 2 to set up your other speaker.

Mounting your speakers

You can mount the speakers on wall brackets, floor stands or table stands. To purchase these accessories, contact your local Bose® dealer or visit www.Bose.com

CAUTIONS:

- Only use Bose hardware to mount the speakers. Using unauthorized mounts may damage your Bose system and its components.
- The speaker wire and interconnect cables included with this system are not approved for in-wall installation. Please check your local building codes for the correct type of wire and cable required for in-wall installation.

Replacing the remote control's batteries

Replace all four batteries when there is a noticeable decrease in range.

1. Slide open the battery compartment cover on the back of the remote control.
2. Install four AA (IEC LR6) 1.5V batteries. Match the + and - symbols on the batteries with the + and - markings inside the compartment.

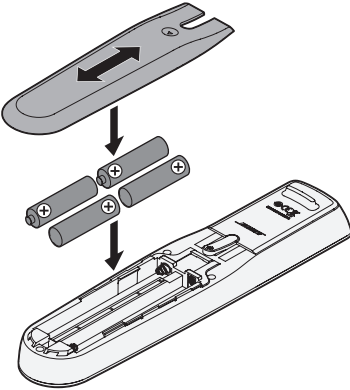

3. Slide the battery compartment cover back into place.

Unable to pair the Acoustimass® wireless bass module with the console

If you are having issues wirelessly connecting your bass module to your console, you can also connect it using a 3.5 mm stereo cable (not provided).

Note: If you do not have a 3.5 mm stereo cable, contact your authorized Bose® dealer or Bose customer service.

To install the 3.5 mm stereo cable:

1. On your remote control, press **SETUP**.
2. Select **Speaker Management**.
3. Follow the on-screen instructions until “The following steps will show you how to set up your bass module” message displays.
4. Press , then follow the on-screen instructions to finish setup.

Unable to pair the wireless receivers with the console (rear speakers)

If you are unable to pair your rear speakers to the console, you can also connect them directly to the system using a custom speaker cable (not provided). Use this method only if you are having issues wirelessly connecting your rear speakers to your console.

Note: To receive the speaker cable, contact your authorized Bose® dealer or Bose customer service.

To install the speaker cable:

1. On your remote control, press **SETUP**.
2. Select **Speaker Management**.
3. Follow the on-screen instructions until “The following steps will show you how to set up your rear speakers” message displays.
4. Press , then follow the on-screen instructions to finish setup.

CAUTION: Do not use any unauthorized wiring to connect the speakers to your Bose system. Using unauthorized wires may damage your Bose system and its components.



799911-0030