

EdgeMax EM180

in-ceiling premium loudspeaker with PhaseGuide technology

Product Overview

Bose Professional EdgeMax in-ceiling premium loudspeakers feature proprietary Bose PhaseGuide technology with high-frequency compression drivers to create a new category that combines the room-filling coverage patterns typical of larger surface-mount speakers with the architect-preferred aesthetics of in-ceiling models. Designed to mount near wall-ceiling boundaries, EdgeMax loudspeakers provide improved audio quality and coverage, while reducing the number of required units, compared to conventional dome-tweeter ceiling speakers.



Key Features

PhaseGuide technology provides a unique asymmetrical vertical pattern for room-filling coverage when mounting near wall-ceiling boundaries

Provides improved room visual appearance for demanding interior designs by eliminating center-of-ceiling or wall-mounted loudspeakers and reducing speaker counts

Nominal 180° horizontal coverage designed for in-ceiling mounting centered along wall coverage zones

High-frequency compression driver for best-in-class audio quality with superior frequency response and coverage consistency versus typical dome tweeters

8-inch woofer with wall-boundary loading provides extended bass impact

2-way passive crossover with 70/100V transformer

New QuickHold spring-loaded mounting arms for fast, easy installs

Magnetically attached grille for quick access to wiring and tap settings

45 Hz - 20 kHz frequency range eliminates need for subwoofers

Coverage pattern similar to a surface-mount loudspeaker enables stereo designs

In compliance with the following safety standards: UL1480A, UL2043

Technical Specifications

SINGLE-LOUDSPEAKER PERFORMANCE		
Frequency Response (-3 dB) ¹	50 - 18,000 Hz	
Frequency Range (-10 dB) ¹	45 - 20,000 Hz	
Nominal Coverage Pattern	180° H × asymmetrical 75° V (0° to 75° referenced to wall)	
	AES transducer test ⁴	Bose extended-lifecycle test ⁵
Power Handling, long-term continuous	150 W	125 W
Power Handling, peak	600 W	500 W
Sensitivity (SPL / 1 W @ 1 m) ²	93 dB	93 dB
Calculated Maximum SPL @ 1 m ³	115 dB	114 dB
Calculated Maximum SPL @ 1 m, peak	121 dB	120 dB
Crossover	1 kHz (passive 2-way crossover with integrated 70/100V transformer)	
Loudspeaker EQ	Recommended but not required	
Recommended High-pass Protection	55 Hz with minimum 12-dB/octave filter	
Overload Protection	Resistor-network power reduction with automatic reset	
Transformer taps	70V: 2.5, 5, 10, 20, 40, 80 W, bypass 100V: 5, 10, 20, 40, 80 W, bypass	
TRANSDUCERS		
Low Frequency	1 × 8-inch woofer (1.5-inch voice coil)	
High Frequency	1 × compression driver (1.3-inch voice coil)	
Nominal Impedance	8Ω (transformer bypass)	

For additional specifications and application information, please visit PRO.BOSE.COM. Specifications subject to change without notice. October 2021.

TECHNICAL DATA

EdgeMax EM180

in-ceiling premium loudspeaker with PhaseGuide technology

PHYSICAL	
Enclosure Material	Engineered-plastics front baffle with integrated steel formed enclosure
Grille	Micro perforated steel, powder-coated finish, white: Bose Arctic White, similar to RAL 9003, paintable
Environmental	Indoor only; UL1480A listed, in compliance with UL2043 for plenum-space installation
Connectors	Euroblock 6-pin connector with loop-through, front-baffle mounted
Suspension / Mounting	Four (4) QuickHold spring-loaded mounting arms plus four (4) M6 safety cable tabs
Maximum Ceiling Thickness	80 mm (3.2 in)
Ceiling Cutout and Clearance	345 × 345 mm (13.6 in L × 13.6 in W) with 236 mm (9.3 in) mounting depth
Product Dimensions (L × W × D)	339 × 339 × 249 mm (13.4 × 13.4 × 9.8 in) enclosure
	390 × 390 × 13 mm (15.4 × 15.4 × 0.5 in) grille flange, as mounted
Loudspeaker Net Weight, single	10.1 kg (22.2 lbs) with grille
Loudspeaker Shipping Weight	12.5 kg (29 lbs)
Tile Bridge Net Weight	1.4 kg (3.1 lbs)
Rough-in Pan Net Weight	1.0 kg (2.2 lbs)
Included Accessories	Each EM180 includes one (1) adjustable tile bridge
Optional Accessories	Black grille, rough-in pan for new construction, ceiling tile replacement accessory
PRODUCT CODES	
EdgeMax EM180 Loudspeaker	777189-0220 (EDGEMAX EM180)
Rough-in Pan for EdgeMax Loudspeaker (pair)	790054-0010 (EDGEMAX EM90/180 ROUGH-IN PAN PAIR)
Black Grille for EdgeMax Loudspeaker	788330-0110 (EDGEMAX EM90/180 BLACK GRILLE SNGL)

Footnotes

1. Frequency response and range measured on-axis in one-eighth-space (corner loaded) environment with recommended Active EQ
2. Sensitivity measured on-axis in one-eighth-space (corner loaded) environment with recommended Active EQ
3. Maximum SPL calculated from sensitivity and power handling specifications, exclusive of power compression
4. AES standard 2-hour duration with IEC system noise
5. Bose extended-lifecycle test using pink noise filtered to meet IEC268-5, 6-dB crest factor, 500-hour duration

For additional specifications and application information, please visit PRO.BOSE.COM.
Specifications subject to change without notice. October 2021.

EdgeMax EM180

in-ceiling premium loudspeaker with PhaseGuide technology

Nominal Coverage and Room Placement

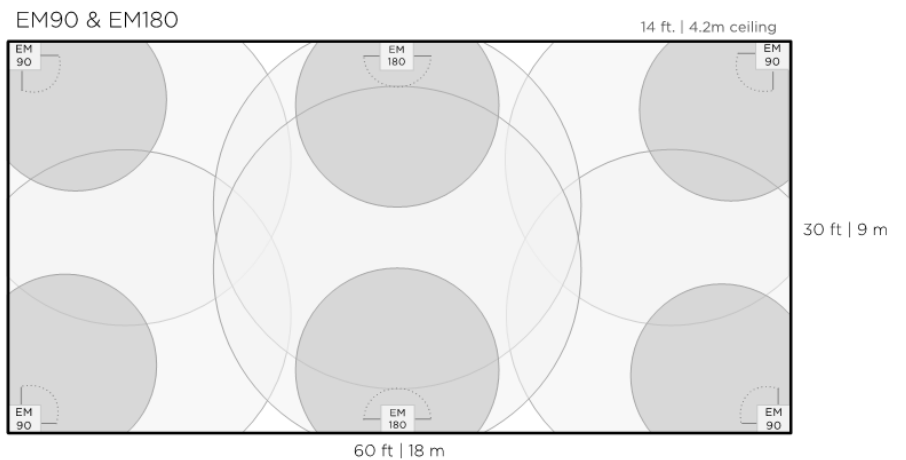
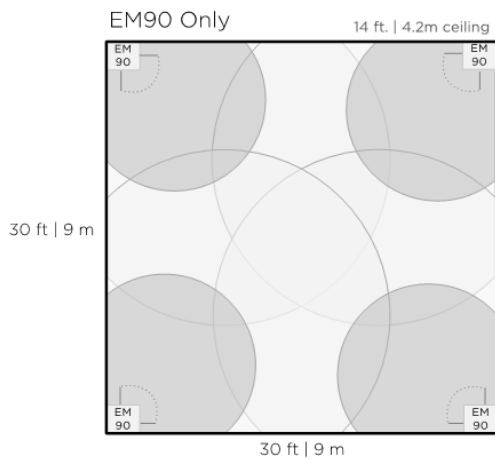
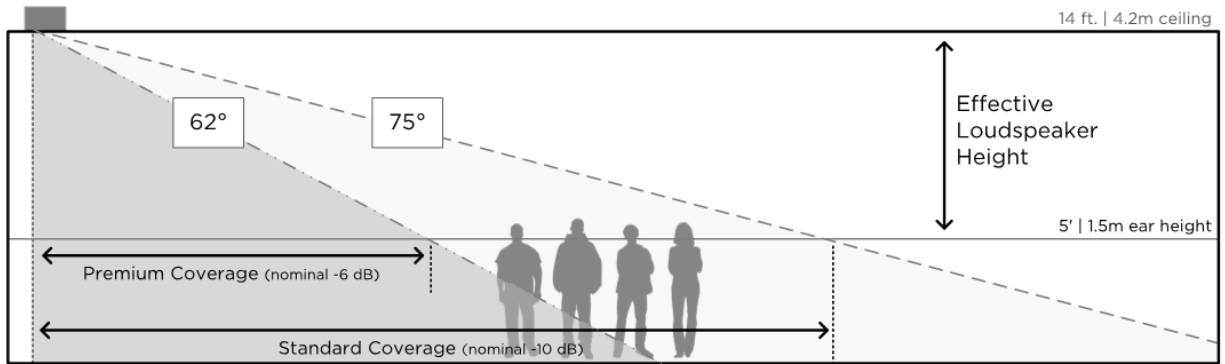

For additional specifications and application information, please visit PRO.BOSE.COM. Specifications subject to change without notice. October 2021.

TECHNICAL DATA

EdgeMax EM180

in-ceiling premium loudspeaker with PhaseGuide technology

Dimensions

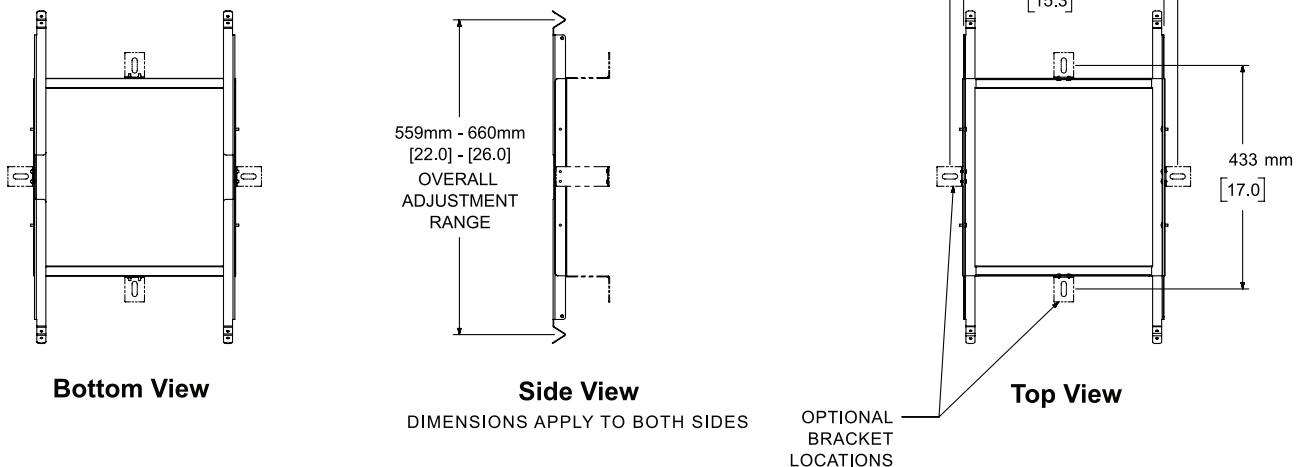
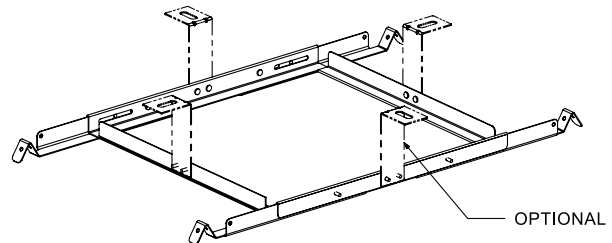
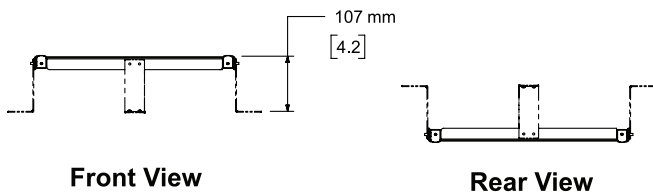
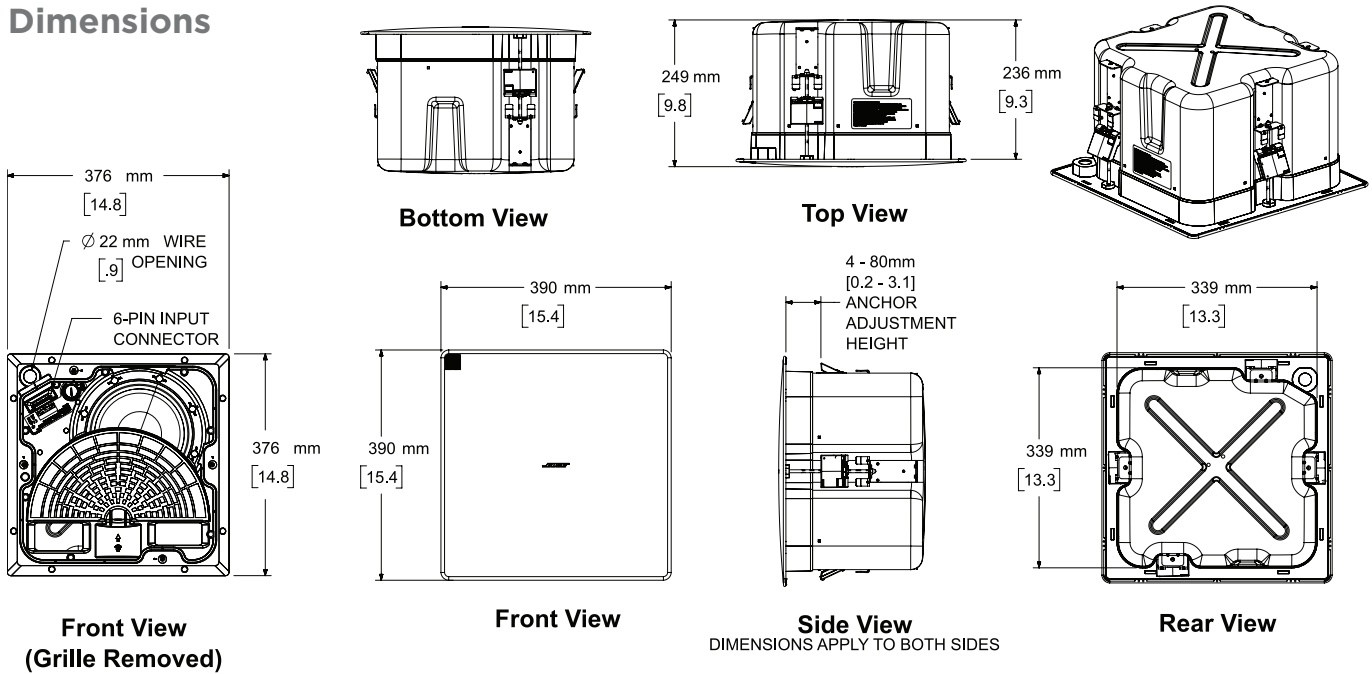

For additional specifications and application information, please visit PRO.BOSE.COM. Specifications subject to change without notice. October 2021.

TECHNICAL DATA

EdgeMax EM180

in-ceiling premium loudspeaker with PhaseGuide technology

Dimensions (Rough-in Pan)

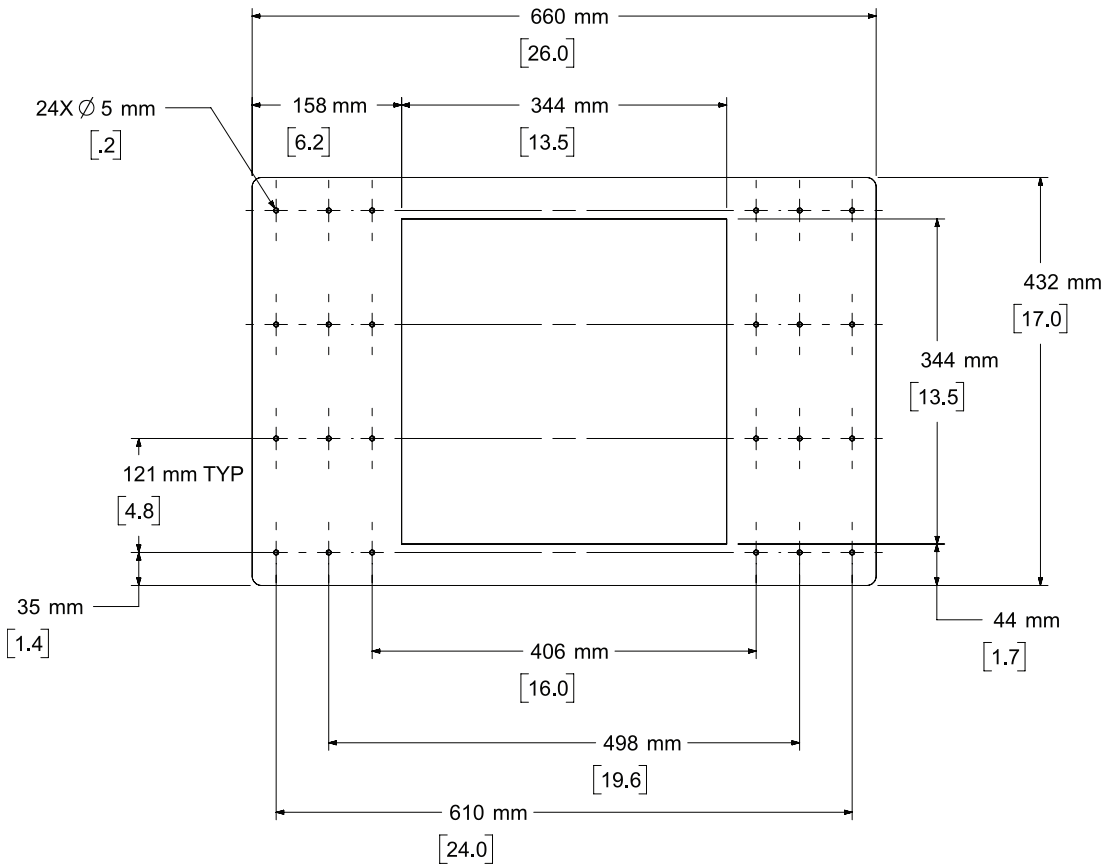

Top View

For additional specifications and application information, please visit PRO.BOSE.COM. Specifications subject to change without notice. October 2021.

EdgeMax EMCT Ceiling Tile Accessory

Product Overview

The EdgeMax Tile accessory is a ceiling tile replacement for use with the EdgeMax EM90 and EM180 loudspeakers, eliminating the need to cut existing ceiling tiles. Simply remove the existing ceiling tile, and use the EdgeMax Tile accessory in its place along with the adjustable tile bridge supplied with the loudspeaker. The EdgeMax Tile is sized perfectly to accept the EM90 or EM180 loudspeaker, saving time and ensuring excellent aesthetics. There are two models available, one sized for a 24 × 24 inch ceiling grid and one sized for a 600 × 600 mm ceiling grid. The EdgeMax Tile accessory is white, sold in singles, is in compliance with UL 2043 for plenum-spaces, and is paintable.



Technical Specifications

PHYSICAL	
Product Dimensions (L × W × D), Americas	595 × 595 × 13 mm (23.4 × 23.4 × 0.5 in)
Product Dimensions (L × W × D), EMEA/APAC	605 × 605 × 13 mm (23.8 × 23.8 × 0.5 in)
EMCT Tile Net Weight (Americas)	2.1 kg (4.6 lbs)
EMCT Tile Net Weight (EMEA/APAC)	2.0 kg (4.4 lbs)
Material	Powder-coated steel; white: Bose Arctic White, similar to RAL 9003, paintable
PRODUCT CODES	
EdgeMax EMCT Ceiling Tile (Americas; 24 in × 24 in)	843297-0210 (EDGEMAX CEILING TILE 24X24 WHT)
EdgeMax EMCT Ceiling Tile (EMEA/APAC; 600 mm × 600 mm)	843298-0210 (EDGEMAX CEILING TILE 600X600 WHT)

Dimensions (EMCT Americas)

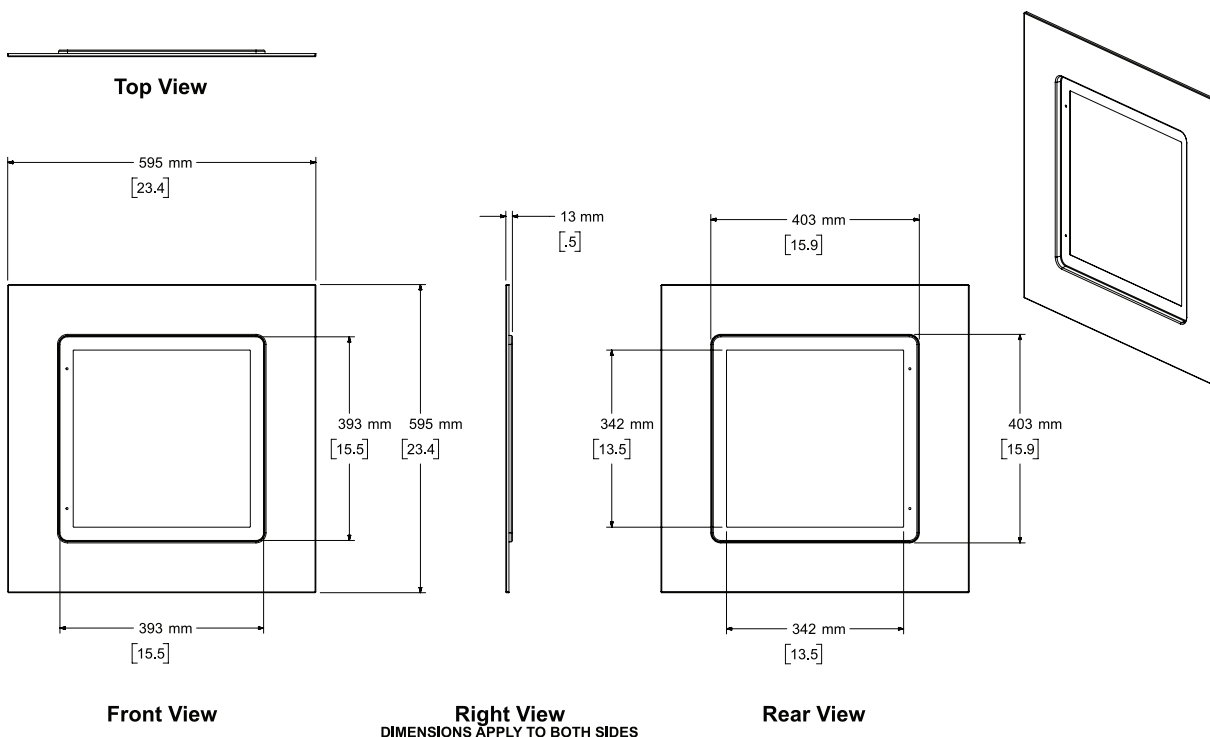

For additional specifications and application information, please visit PRO.BOSE.COM. Specifications subject to change without notice. October 2021.

EdgeMax EMCT Ceiling Tile Accessory

Dimensions (EMCT EMEA/APAC)

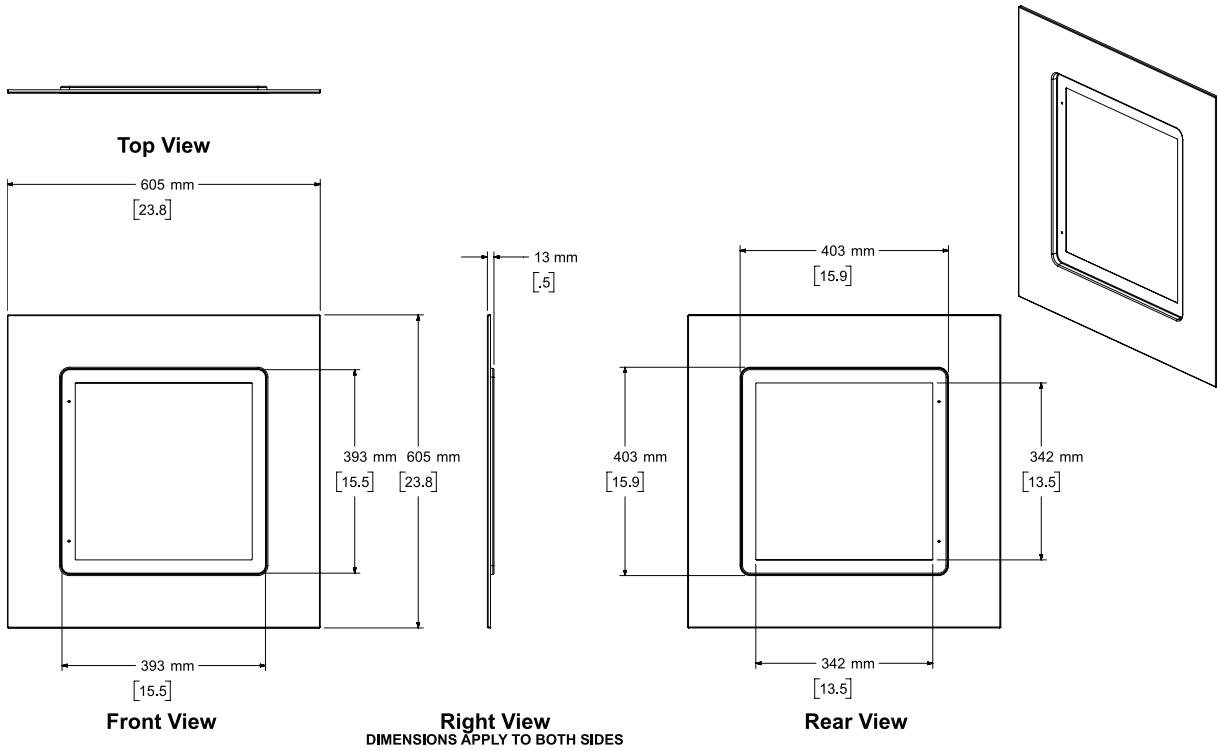

For additional specifications and application information, please visit PRO.BOSE.COM. Specifications subject to change without notice. October 2021.