

The Bose® 251™ Environmental Speakers

Owner's Guide

Brugervejledning

Bedienungsanleitung

Guía del usuario

Notice d'utilisation

Manuale di istruzioni

Gebruiksaanwijzing

Bruksanvisning

BOSE®



For your records...

Serial numbers are located on the label on the back of each 251™ environmental speaker.

Serial numbers: _____ and _____

Dealer name: _____

Dealer phone: _____ Purchase date: _____

We suggest you keep your sales slip and warranty card together with this owner's guide.

Where to find...

Setting Up
 Before you begin 4
 Unpacking the carton 4
 Tools required 4
 Selecting the location for your speakers 5
 Installing Your 251™ Speakers
 Choosing the speaker wire 6
 Installing the mounting brackets 6
 Attaching the speakers to the brackets 8
 Making the connections 9
 Maintaining Your 251™ Speakers
 Troubleshooting 12
 Warranty period 12
 Customer service 12
 Cleaning your speakers 12
 Protecting the speaker wire 12
 Product Information
 Technical information 13
 Bose® Corporation inside back cover

English

Dansk

Deutsch

Español

Français

Italiano

Nederlands

Svenska

Before you begin...

Thank you for purchasing Bose® 251™ environmental speakers. These high-performance outdoor speakers are engineered to provide sound quality far beyond that of other environmental speakers. The 251 environmental speakers are designed to withstand nature's elements – so you can be confident they will perform for years to come.

Unpacking the carton

Carefully unpack your speakers and save all packing materials for possible future use. Check that your system contains the parts identified in Figure 1. Do not attempt to use your speakers if any part of them appears damaged. Instead, notify Bose Corporation or your authorized Bose dealer immediately.



WARNING: To avoid danger of suffocation, keep the plastic bags out of the reach of children.

Figure 1

Packaging contents:

- Two 251 speakers
- Two mounting brackets
- Mounting hardware (8 screws and 8 plastic anchors)
- Six rubber feet
- Four knobs
- One owner's guide

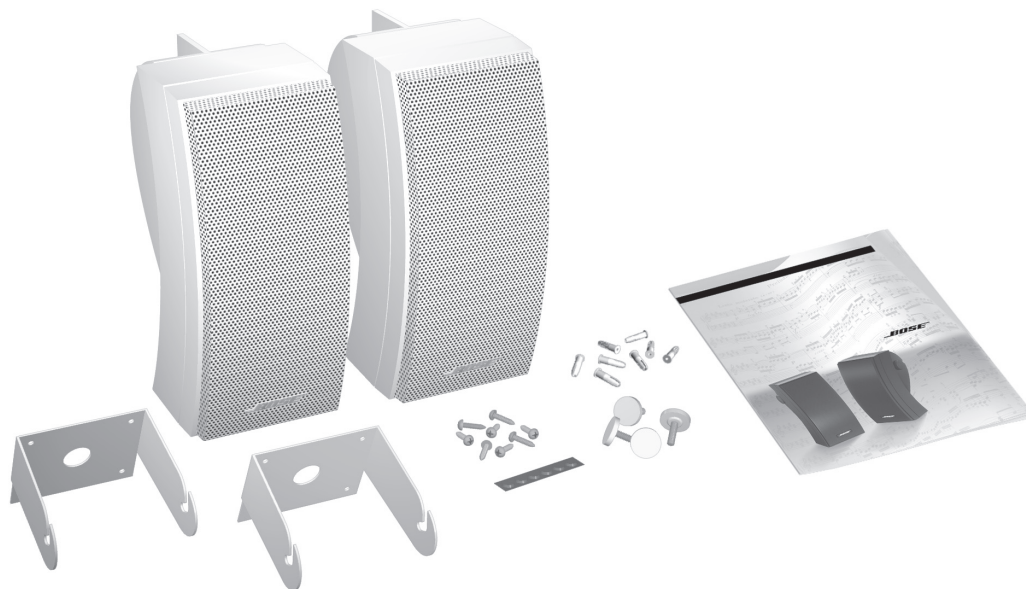

Tools required

You need the following items to complete this installation:

- Speaker wire (see “Wire recommendations” on page 13)
- Phillips-head screwdriver (#2)
- A drill with the following bits:
 - A $\frac{3}{32}$ inch diameter (2,5 mm) bit is preferred, or you can use a $\frac{1}{8}$ inch diameter (3,0 mm) bit. For concrete, a $\frac{1}{4}$ inch (6,0 mm) diameter masonry bit can be used.
- Eye and ear protection
- Dust mask



CAUTION: Failure to follow the instructions in this owner's guide voids all warranties on your speakers. If you are unsure of your ability to complete this process, consult a professional installer. Please read this owner's guide completely before beginning installation.

Selecting the location for your speakers

For best results, mount both speakers on the same wall, facing the listening area. Make sure they do not face each other. (Outdoors, if you are not using an existing wall, consider the length of your listening area as your “wall.”)

The 251™ speakers should be placed at least 7 feet (2 m) apart.

Please consider the following before mounting your speakers:

- Measure the length of speaker wire you need to connect each speaker to your receiver or amplifier. To determine the wire gauge you will need, refer to the “Wire recommendations” on page 13.
- It is important that the speaker wire not be tripped over, pinched, or pulled. Determine the best route to protect the wire.



CAUTION: Do not mount on surfaces that are not sturdy enough, or that have hazards concealed behind them, such as plumbing or electrical wire. If you are unsure about installing these speakers, contact a qualified professional installer.

- Regardless of where you place your speakers, make sure they cannot fall and cause injuries.
- Bose® 251 speakers are not magnetically shielded. Keep them at least 9 inches (23 cm) from any video screen or monitor.



Note: This product is not intended for use in areas where it will be subject to high vibration. If you are unsure about installing these speakers, contact a qualified professional installer.

Figure 2

Speaker placement guidelines



Choosing the speaker wire

Be sure to use the proper gauge (thickness) of speaker wire. Standard zip cord (2-conductor, 18-gauge wire found at electrical and hardware stores) works for most applications. If your speakers will be more than 30 feet (9 m) from the receiver or amplifier, see the “Wire recommendations” under “Technical Information” on page 13. Or check with your authorized Bose® dealer.

If you decide to run the speaker wire through a wall or underground, check your local building code requirements, or contact an electrical installer before proceeding.



Note: Be sure to cut enough wire to reach from the receiver to each speaker.



CAUTION: Before making any connections, turn off your receiver or amplifier and unplug it from the outlet (the AC power mains).

Installing the mounting brackets

The 251™ speakers should be mounted using the supplied brackets. They can be mounted onto the exterior of a house or onto a deck railing or table. If you choose not to use the supplied brackets, be sure to position your 251 speakers on a sturdy surface.



CAUTION: If you do not use the supplied brackets, choose a level surface for the speakers. Vibration can cause the speakers to move, so it is important that you install the supplied rubber feet before using the speakers on a surface. Refer to “Attaching the rubber feet” on page 11.

Installing the brackets onto the exterior of a house

The 251 speakers should be mounted in a vertical position to achieve the best musical performance. Figure 3 illustrates how the mounted speaker will look once the installation is complete. To begin, mark four holes to indicate where you want to install the speaker bracket (Figure 4). For wood, drill four starter holes using a $\frac{7}{32}$ inch (2,5 mm) drill bit (Figure 5). For cement, drill four starter holes using a $\frac{1}{4}$ inch (6,0 mm) drill bit (Figure 5).

Figure 3

251 environmental speaker mounted onto the exterior of a house

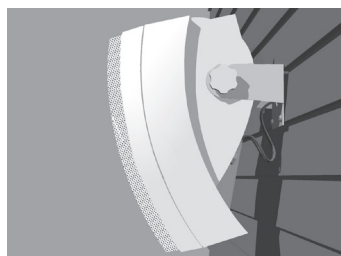

Figure 4

Marking four holes on the exterior of a house

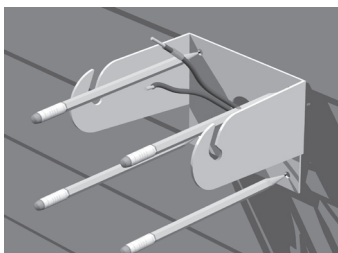
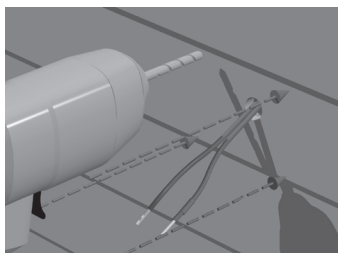

Figure 5

Drilling four holes on the exterior of a house



Installing the mounting brackets (cont.)

Installing the brackets onto the exterior of a house (cont.)

For mounting onto wood, install the supplied screws using a Phillips-head screwdriver (Figure 6A). For concrete use, first install the supplied plastic inserts. Then, using a Phillips-head screwdriver, install the screws (Figure 6B).

Figures 6A and 6B

Installing the hardware

- A. Wood
- B. Concrete

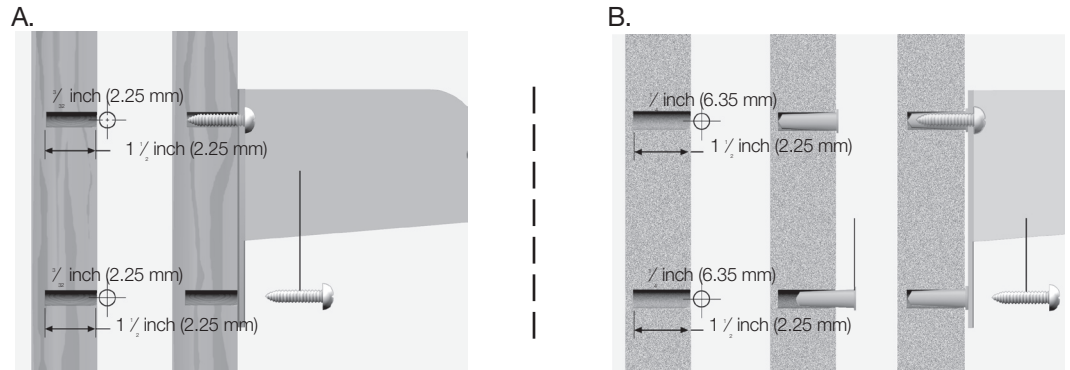

Installing the brackets onto a deck railing or table

The 251™ speakers should be mounted in a vertical position to achieve the best musical performance. Figure 7 illustrates how the mounted speaker will look once the installation is complete. To begin, mark four holes to indicate where you want to install the speaker bracket (Figure 8). Then, drill four starter holes using a 3/32 inch (2,5 mm) drill bit (Figure 9).

Figure 7

251 environmental speaker mounted onto a deck railing or table

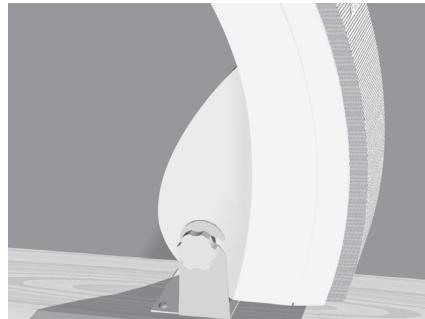

Figure 8

Marking four holes on a deck railing or table

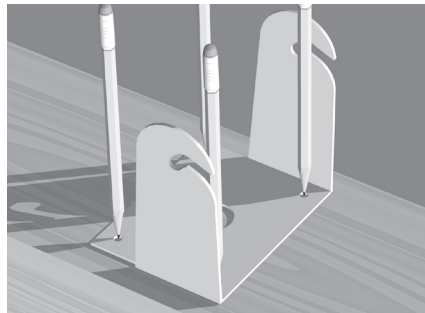
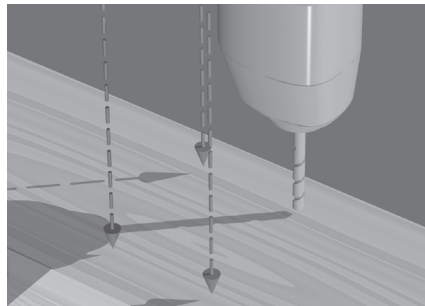

Figure 9

Drilling four holes on a deck railing or table



Installing the mounting brackets (cont.)

Installing the brackets onto a deck railing or table (cont.)

Finally, install the four screws using a Phillips-head screwdriver (Figure 10).

Figure 10

Installing the bracket onto a deck railing or table

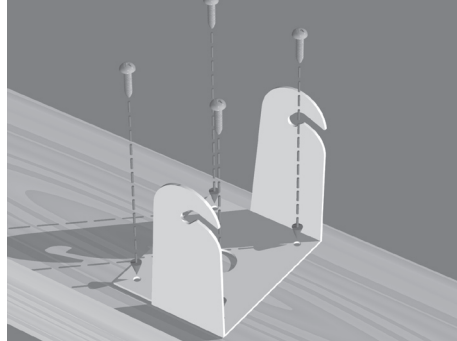

Note: If you are mounting your 251™ speakers on a deck railing or table, you will need to rotate the Bose logo. Refer to “Rotating the Bose logo” on page 11 for instructions on how to do this.

Attaching the speakers to the brackets

Once the brackets are installed, carefully follow these steps to attach the speakers to the brackets. First, insert the knobs into each side of the speakers. Be sure to turn each knob two full rotations (Figure 11). Then, carefully slide the speakers into the brackets (Figure 12). Finally, temporarily tighten the speaker in a position that will allow you to easily connect the speaker wire (Figures 13A and 13B).

Figure 11

Installing the knobs

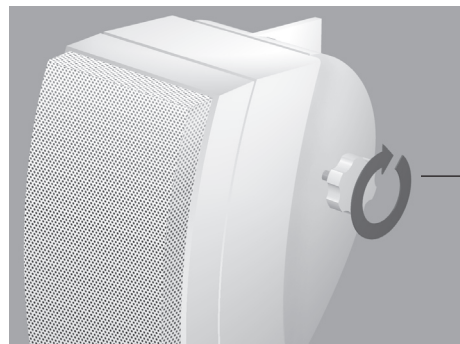

two full rotations

Figure 12

Sliding the speakers into the brackets

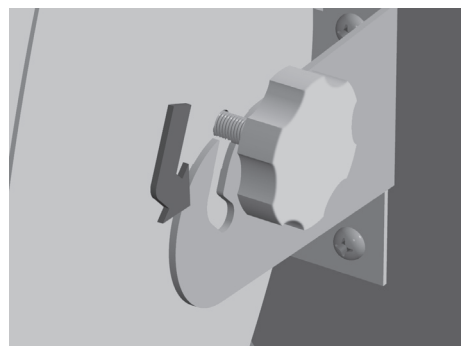

Attaching the speakers to the brackets (cont.)

Figures 13A and 13B

Temporarily tighten the speakers to the brackets

- A. Exterior of the house
- B. Deck railing or table

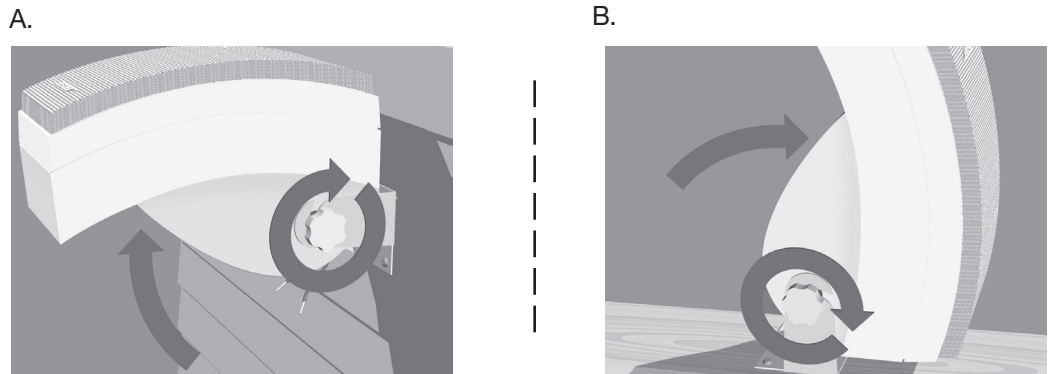

Making the connections

Preparing the speaker wire (not provided)

Speaker cord consists of two insulated wires. The insulation around one wire is striped, collared, or ribbed. This marked wire is positive (+). The plain wire is negative (-). These correspond to the red (+) and black (-) terminals on the back of the speaker, receiver, or amplifier. Be sure to connect each wire to the proper terminal (positive to positive, negative to negative).

Figure 14

Preparing the ends of each wire

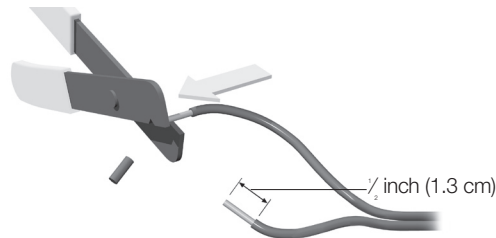

At the ends of each cord, strip approximately $\frac{1}{2}$ inch (1.3 cm) of insulation from both wires (Figure 14). Next, twist the ends of each wire so there are no loose strands.

Connecting the speaker wire to the speakers

At the back of your speaker, unscrew the hex knobs on the terminal posts. This reveals a small opening through each post (Figure 15). Using the wire guides, insert the marked wire into the red (+) terminal. Then insert the plain wire into the black (-) terminal. Tighten the knobs to secure the wires. See Figures 16A and 16B on page 10.

Figures 15

Unscrewing the hex knob

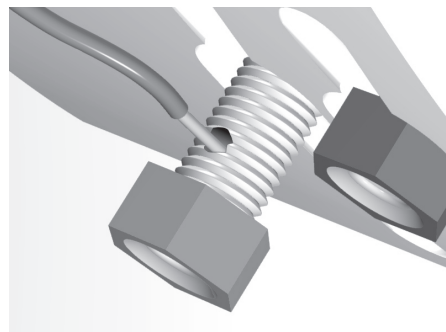

Attaching the speakers to the brackets (cont.)

Figures 16A & 16B

Connecting the speaker wire

A. Exterior of a house

B. Deck railing or table

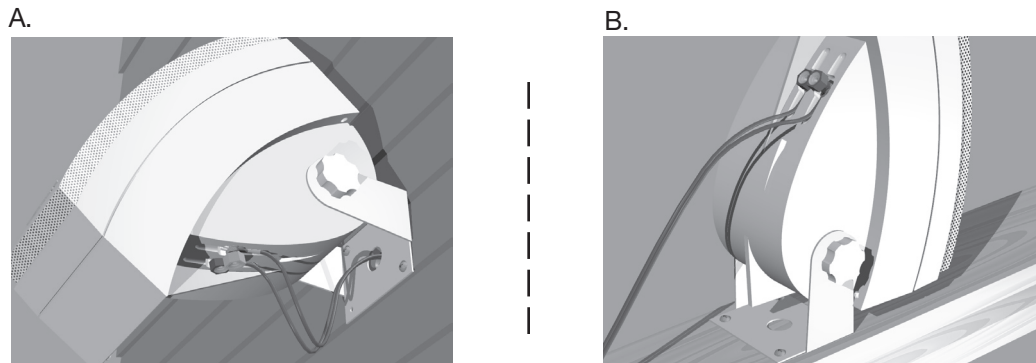

Connecting the speaker wire to the receiver or amplifier

1. Connect the speakers on the left side of the listening area to the left channel of your receiver or amplifier (Figure 17).
 - a. Attach the marked wire to the red (+) terminal.
 - b. Attach the plain wire to the black (-) terminal.
2. Connect the speaker on the right side of the listening area to the right channel of your receiver or amplifier, following the same procedure above (Figure 17).



Note: If your 251™ speakers are being connected as a secondary set of speakers to your receiver or amplifier, be sure to make the appropriate connections to the “B” channel.

Figure 17

Connecting the speaker wire

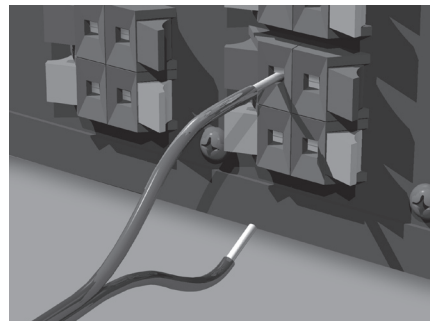

Checking the connections

Check the speaker connections carefully. Make sure no loose strands of wire touch across terminals. This could create short circuits that can damage an amplifier or receiver.

Tighten any loose connections before you plug in the receiver or amplifier.

Testing the connections

To make sure your speakers operate correctly, follow these steps:

1. Set the balance control on your receiver or amplifier to normal (centered).
2. Play some deep bass passages of music through the speakers.

The sound should seem to come from a point between the two speakers. The bass should be full and natural. If not, your connections may be reversed, causing the speakers to play out of phase. Refer to “Making the connections” on page 9. To correct the problem, make sure all the wires are connected positive to positive (+ to +) and negative to negative (- to -). Then repeat steps 1 and 2 to re-test the speakers.

Making the connections (cont.)

Putting the speakers in the final location

Loosen the knobs on each speaker to rotate the speakers into the desired position. Then, tighten the knobs to secure the speaker in its final position (Figures 18A and 18B).

Figures 18A and 18B

Putting the speaker in the final position

- A. Exterior of the house
- B. Deck railing or table

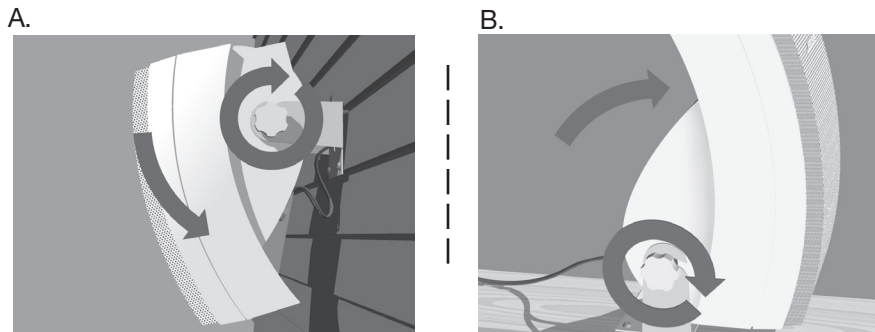

Attaching the rubber feet

If you do not plan to use the supplied brackets to mount your 251 environmental speakers, you can place them on a sturdy, level surface. They should be standing in the vertical position. Be sure to attach the rubber feet before using your speakers. For proper balance be sure to place the feet in the position shown in Figure 19.

Figure 19

Attaching the rubber feet

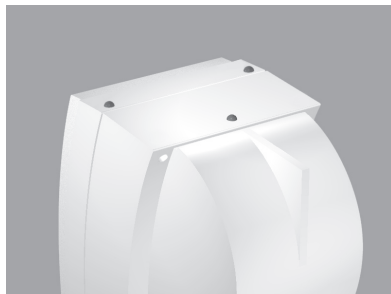

Rotating the Bose logo

Mounting the speakers on a deck railing or table will require you to rotate the Bose logo. Using your fingers, gently lift the logo, taking care not to detach it from the speaker, about $\frac{1}{4}$ inch (.24 cm) and turn it 180°.

Figure 20

Rotating the Bose logo

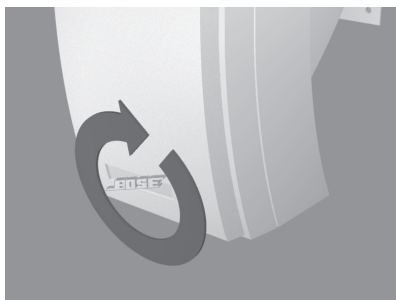

Troubleshooting

English

Problem	What to do
Neither speaker plays	<ul style="list-style-type: none"> • Check the settings on your receiver or amplifier. Refer to the owner’s guide that came with it for instruction on settings. • If your 251™ speakers are connected as a second set of speakers to your receiver or amplifier, check that the connections have been made to the “B” terminals and that the “B” speakers are selected to play.
The bass or treble is weak	<ul style="list-style-type: none"> • Check the tonal balance setting on your receiver or amplifier.
Only one speaker plays	<ul style="list-style-type: none"> • Check the balance control on your receiver or amplifier and make sure it’s centered. • Check the wires connected to the speaker that does not play. Make sure the wires are in good condition and are firmly connected. Review the “Making the connections” section on page 9. • Disconnect the working speaker from the receiver or amplifier. • Switch the cord of the “faulty” speaker from its original receiver or amplifier jacks to the other set of jacks (the working speaker was originally attached to those jacks). <ul style="list-style-type: none"> - If the speaker now works, the problem is in your receiver or amplifier. Reconnect your speakers to a working unit. - If there is still no sound from the speaker, continue below. • Remove the cord from the working speaker and connect it to the “faulty” speaker. <ul style="list-style-type: none"> - If the speaker now works, the problem was in the original speaker cord. - If there is still no sound, the problem is in the speaker. • If trouble persists, contact your authorized Bose® dealer, who will arrange for service. Or, contact Bose customer service. See the inside back cover of this owner’s guide for a list of phone numbers.
Only one speaker still plays	

Warranty period

Bose 251 environmental speakers are covered by a limited five-year transferable warranty. Details of coverage are on the warranty card that came with your speakers. Please fill out the information section, detach, and mail it to Bose.

Customer service

For additional help in solving problems, contact Bose Customer Service. See the inside back cover for offices and phone numbers.

Cleaning your speakers

Use a cloth dampened in mild detergent and water to remove dust or dirt from the outside of your 251 speakers. Or use a hose to rinse them thoroughly with fresh water. Do not use enough pressure to force water behind the grille and into the drivers or the acoustic ports.

Protecting the speaker wire

The bare ends of the speaker cord can be affected by exposure to the elements. This is especially true of saltwater exposure. You may use a silicone caulking material, such as RTV adhesive, to protect the connections. It is commonly available at hardware stores. If you do use caulking, apply it only after the wires are connected and the knobs tightened down. Check the connections annually, and reapply as needed.

Technical Information

Protective features

- Galvanized powder coated steel grille
- Environmentally resistant hardware
- Polymer fiber composite drivers
- Nickel-plated brass connection terminals
- Syncom® computer quality control

Driver complement

- Two (2) 2 $\frac{1}{2}$ " environmental Twiddler™ drivers per speaker
- One (1) 5 $\frac{1}{4}$ " environmental woofer per speaker

Enclosure

- Dual-port molded polypropylene composite
- Black or white

Dimensions

- 13 $\frac{1}{2}$ " H x 5 $\frac{3}{4}$ " W x 8" D (34.29 cm x 14.6 cm x 20.32 cm)

Compatibility

- Compatible with amplifiers or receivers rated 10-200 watts per channel/rated 4 to 8 ohms
- 100W IEC continuous power handling; rated 6 ohms

Environmental Capabilities

- Designed to withstand:
 - salt fog, sun, high humidity (100%RH)
 - temperature extremes (-40°F to 158°F; -40°C to 70°C)

Wire recommendations

- Based on a maximum frequency response deviation of ± 0.5 dB

<i>Gauge</i>	<i>Length</i>
18 (0.75 mm ³)	30 ft (9 m) maximum
16 (1.5 mm ³)	45 ft (14 m) maximum
14 (2.0 mm ³)	70 ft (21 m) maximum

Weight

- 8 lb (3.63 kg) each

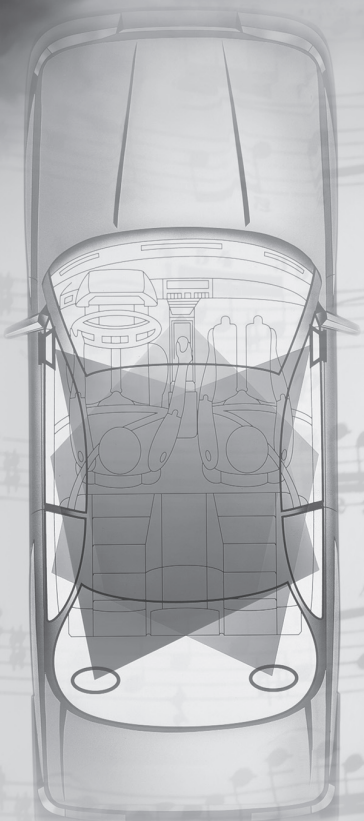
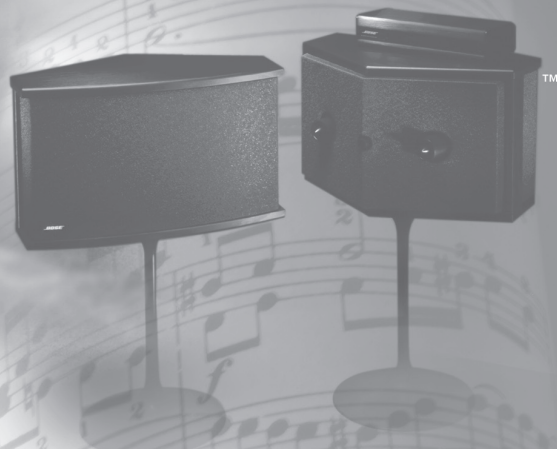
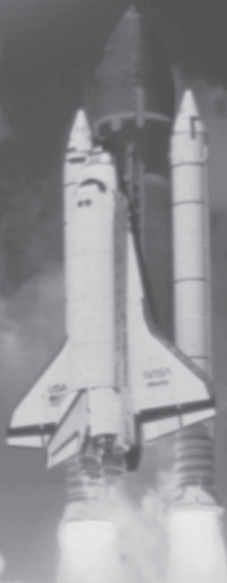

BOSE[®]
Better sound through research[®]



250811

© 2008 Bose Corporation, The Mountain
Framingham, MA 01701-9168 USA
AM250811 Rev.06